

## IQ3xcite WEB ENABLED CONTROLLER

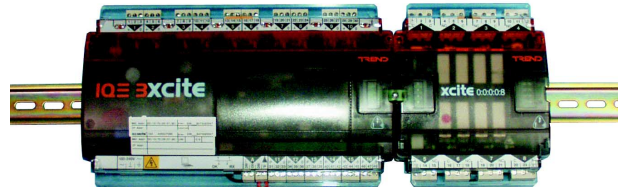

### Description

The IQ3xcite is a Building Management System controller that uses Ethernet and TCP/IP networking technologies. It incorporates a web server which can deliver user-specific web pages to a PC or mobile device running internet browser software. If a system is set up with the correct connections, a user with the appropriate security codes can monitor or adjust the controller from any Internet access point in the world. It is also compatible with the traditional Trend protocol. This DIN rail mounting controller has a basic version with 10 inputs and 6 outputs, and an expandable version which can have up to 96 points by adding DIN rail mounting I/O modules. This flexibility makes it suitable for a broad range of applications. A local PC or display (SDU-xcite) can be connected via the RS232 port.

### Features

- Ethernet 10 Mbps main network with TCP/IP protocol
- embedded web server
- security protected monitor/control via web browser
- compatible with existing Trend protocol
- basic unit has 10 universal inputs, and 6 analogue outputs
- option of 80 additional points via DIN rail I/O modules
- I/O bus allows separate placement of modules
- flexible number of software strategy modules
- RS232 local supervisor port
- local display (SDU-xcite)
- reliable I/O bus
- small footprint with DIN rail mounting

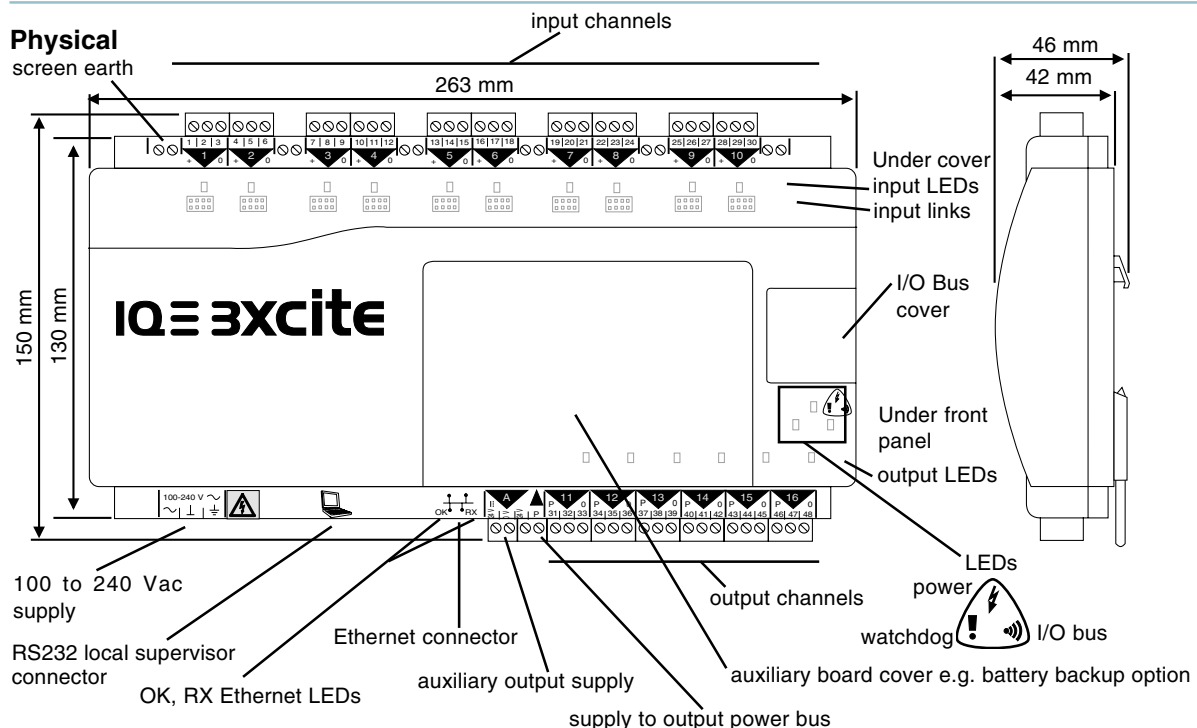

**Physical** (continued)  
I/O Module (e.g. 8 universal input)

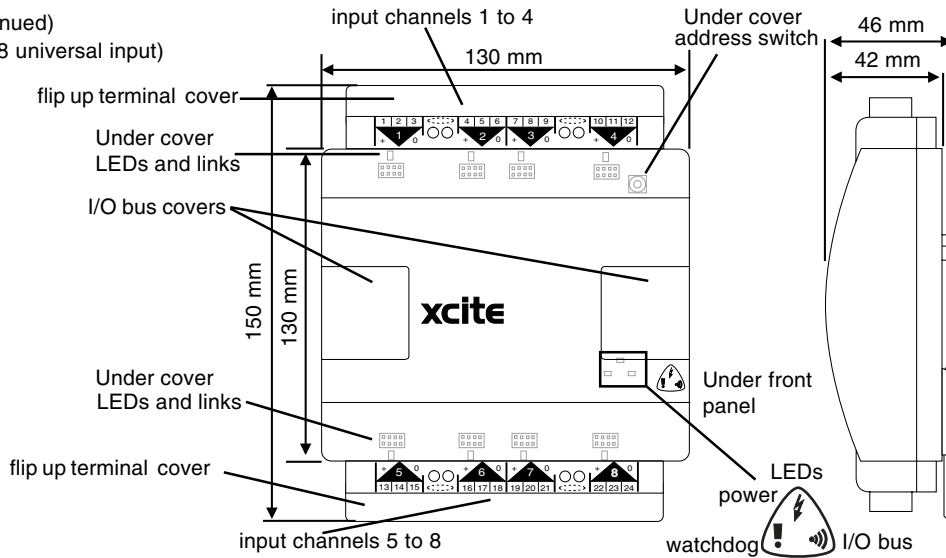

**FUNCTIONALITY**

This data sheet gives a general description of IQ3xcite. Detailed information is given in the following manuals:

- SET Manual TE200147 covers IQ3xcite's configuration modules
- Trend Ethernet Products Engineering Manual TE200369 covers the use of IQ3xcite with Ethernet
- IQ3xcite Web User Guide covers the use of Web Pages
- IP Tool Manual TE200638 describes the use of the IP Tool.

The IQ3xcite functionality can be divided into four sections: system, hardware, firmware, and strategy.

**SYSTEM**

**Standard Communications**

The basic IQ3xcite has Ethernet, I/O bus, and RS232 ports.

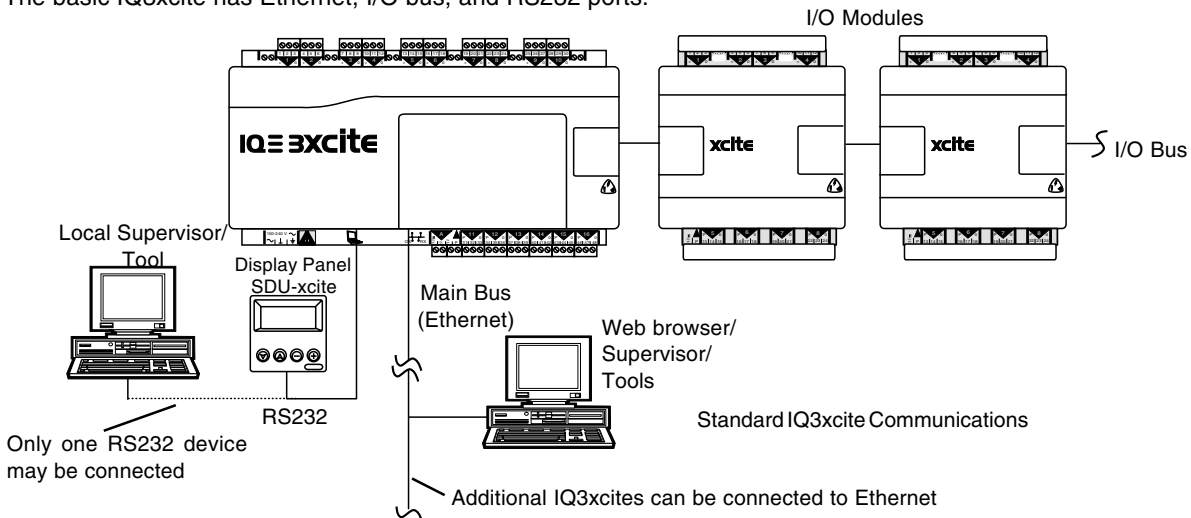

**Ethernet:** This is the main network for the IQ3xcite controller. It enables PCs to connect directly to Ethernet and communicate with the IQ3xcite using IP addressing. It also enables Inter-Controller Communications (IC Comms - peer to peer Ethernet communications) between controllers. Remote PCs can communicate via standard IT networks (e.g. the Internet) using IP, enabling communication from anywhere in the world. The IP connection will support a web browser (thin client) running in a PC, but communication with a Trend supervisor or tool (thick client) will require the use of the virtual CNC embedded in the IQ3xcite controller.

**I/O bus:** The controller has a highly reliable I/O bus. This enables expansion I/O modules to be connected to give up to 80 additional I/O points (96 points in total with the 16 points in the IQ3XCITE/16/..). The bus can be up to 10 m or 30 m in length (see page 8 for details), and have a maximum of 15 I/O modules.

**RS232 port:** A 4 line display panel (SDU-xcite), or a local PC running a supervisor or a software tool may be connected via the RS232 port. Only one device may be connected. This port can communicate directly with the IQ3xcite (address 0)

or to the virtual Lan via an internal CNC connection (see below). The SDU-xcite communicates only with the local IQ3xcite. For the RS232 port to operate with SDU-xcite, its address module local supervisor port address must be set to zero

**Virtual Networks:** The IQ3xcite will create its own virtual Lan which includes a node for its own controller, a CNC for its local supervisor port (if supervisor port address is set non-zero), a virtual CNC, and a virtual INC (address 126). If multiple IQ3xcites with the same Lan number are connected to Ethernet, then a virtual Lan will form to include these IQ3xcites and their internal nodes. The IQ3xcite with the lowest IP address also assumes the INC functionality (the other virtual INCs disappear) and is responsible for maintaining the virtual Lan across the IQ3xcites. If multiple IQ3xcites with different Lan numbers are connected to Ethernet then their INCs will form an internetwork (along with any EINC on the network).

*Note that an IQ3xcite set to 'Stand alone' mode by IP Tool will not build networks on Ethernet although it will still build its internal Lan, and RS232 and I/O Bus comms still operate. If a working Ethernet connection is not made, the RS232 communications (e.g. SDU-xcite) may not operate until about 10 mins after power up.*

**Standard Communications** (continued)

**IC Comms:** The IQ3xcites may communicate with each other and earlier IQ (and IQL) controllers using Inter Controller Communications (peer to peer communications). This will use Trend Lan/node addressing (not direct IP addressing). This is initially limited to a subset of IQ2 IC Comms and excludes receipt of visitor comms (min, max, sum and average messages)

**Alarm Delivery:** Alarms can be delivered normally to the local supervisor port or to a supervisor making a permanent connection to the virtual CNC. If supervisors are making temporary connections to the virtual CNC, then alarms going over Ethernet must be sent to the target supervisor via a virtual CNC set to alarm mode within an EINC.

**System Configurations**

**Single IQ3xcite:** The following diagram shows an IQ3xcite connected via Ethernet to PC B connected running a web browser, and PC A running a Supervisor or Tool software. A local PC, C, is connected directly via RS232.

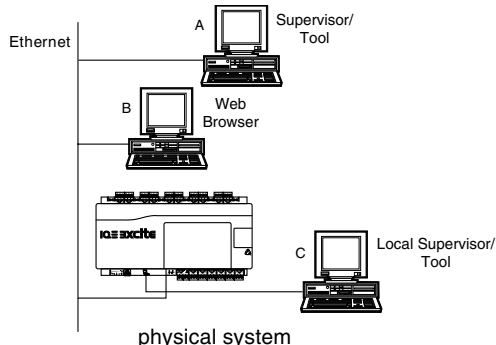

The diagram below shows the equivalent virtual Lan constructed within the IQ3xcite consisting of the controller's CNC, C's CNC, A's CNC, and the virtual INC. PC B on Ethernet communicates directly with the IQ3xcite using TCP/IP. If PC A makes a permanent connection to the IQ3xcite's CNC then the IQ3xcite alarms may be sent to it.

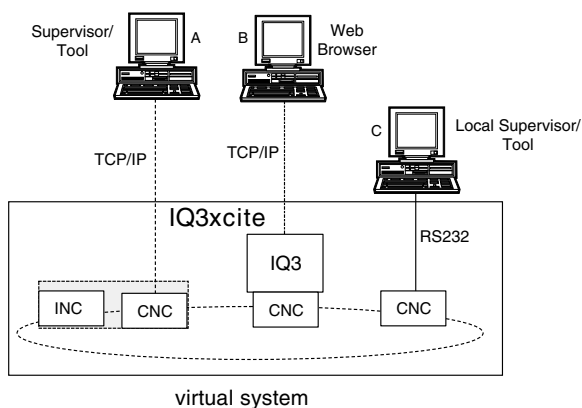

**Stand alone IQ3xcite:** An IQ3xcite can be set to 'Stand Alone' by the IP tool. It will not attempt to build networks with other IQ3xcites or EINC's, but will still communicate as a single IQ3xcite as above (with supervisor, web browser, and local supervisor). A controller should be set to stand alone mode to reduce Ethernet network traffic (i.e. to disable polling messages trying to 'find' other Trend devices).

*Note that if a working Ethernet connection is not made, the RS232 communications (e.g. SDU-xcite) may not operate until about 10 mins after power up.*

**Multiple IQ3xcites:** The diagram below shows an additional IQ3xcite connected to Ethernet.

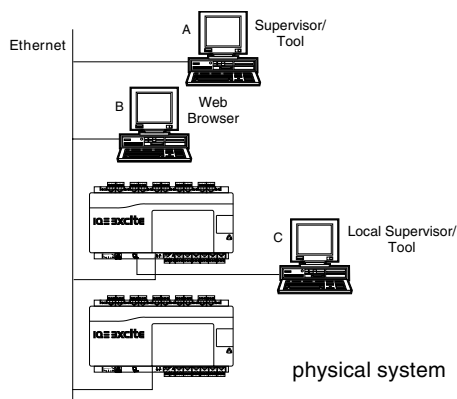

If the two IQ3xcites have the same Lan number, their two virtual Lans combine.

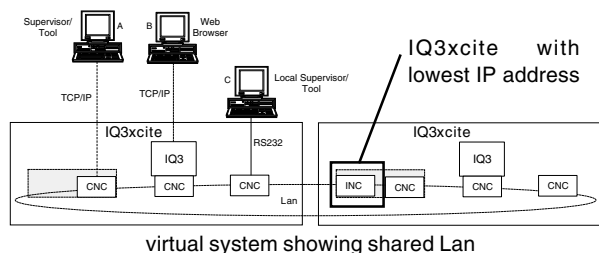

In the virtual system diagram it can be seen that the IQ3xcite with the lowest IP address takes over the INC functions for the Lan, and the other IQ3xcite loses its INC.

If the IQ3xcites have different Lan numbers they connect together via a virtual internetwork.

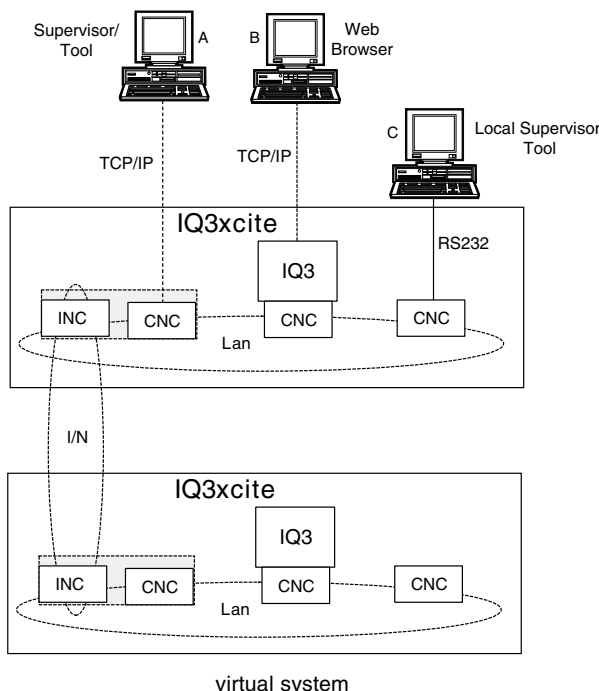

The above diagram shows such a virtual internetwork. The local PC, C, may communicate only with its directly connected IQ3xcite if the port address is set to zero, but if non-zero it can communicate with any other device on the Trend network. If PC A makes a permanent connection to the IQ3xcite's virtual CNC then alarms from either of the IQ3xcites can be sent to this virtual CNC. The web browser, B, can make a temporary connection to either IQ3xcite, and also an IQ3xcite's display pages may be linked to those of another IQ3xcite. The IQ3xcites can communicate with each other using IC Comms.

*Note that an IQ3xcite set to 'Stand alone' mode by IP Tool will not build networks on Ethernet.*

**System Configurations** (continued)

**Routers:** IQ3xcites are able to construct an internetwork across a router. However, it is possible for PCs to connect to IQ3xcites via routers, and to treat IQ3xcites separated by routers as separate sites.

**Connecting a PC to an IQ3xcite via a Router :**An Ethernet connected PC running Trend software (e.g. 963) may use an IQ3xcite virtual CNC via a router.

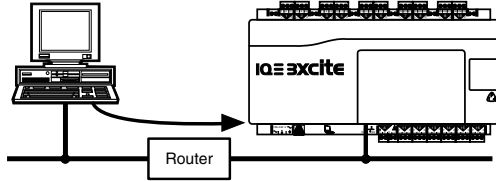

This is done by setting up a router IP address in the PC. In addition the default router IP address must be set up within the IQ3xcite, so that TCP/IP messages from the IQ3xcite are transferred through the router (to the PC). The router used in each case must be on the same subnet as the device using it (PC or EINC).

**Using a Supervisor with Multiple Sites :**In the diagram below there are two IQ3xcites either side of a router.

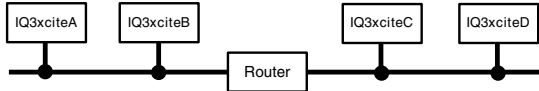

If the IQ3xcites are not set up to span the router as described below, they will construct two separate internetworks either side of the router.

Only one internetwork is allowed on a site, but the Supervisor can treat the internetworks as separate sites, and change the IP address of the IQ3xcite virtual CNC it is using as it switches sites. *Note that there cannot be any IC comms between the sites.* Alarms cannot be sent to the supervisor unless EINC's are used (see below).

**Setting up IQ3xcites to span Routers :**This is done by firstly setting the 'Router 1' IP address in the address module. Then by entering the IP address, and subnet mask in one of the **remote Trend device** modules (n=1 to 20) for an IQ3xcite the other side of the router.

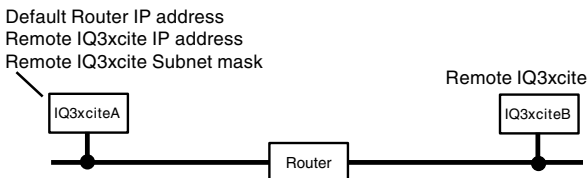

In the above diagram, IQ3xciteA is configured with the default router IP address and the remote IQ3xcite's (IQ3xciteB's) IP address and subnet mask. It will now send a message to IQ3xciteB's subnet via the default router. IQ3xciteB will then reply and the IQ3xciteA will construct the internetwork between the two IQ3xcites.

If more than one router is involved, IQ3xciteB will also have to be set up to create an internetwork with IQ3xciteA by entering the default router IP address and IQ3xciteA's IP address and subnet mask.

The setting up of several IQ3xcites across routers requires that details of at least one IQ3xcite from every subnet must be set up in the **remote Trend device** modules. A remote IQ3xcite will need similar details to be set up but its details must also contain the details of the original IQ3xcite. With reasonable risk two devices from each subnet could be used.

**It is recommended that the two lowest IP addresses (either EINC's or IQ3xcites) one side of a router have details of the two lowest IP addresses (either EINC's or IQ3xcites) on each subnet of the system the other side of the router.**

**Multiple routers:** The default router can be any router on the same subnet as the device using it. It will pass the message to a router on the remote IQ3xcite's subnet.

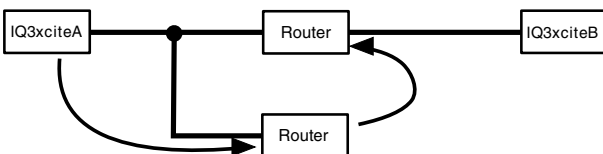

**Multiple IQ3xcites :**As explained above in 'Using a Supervisor with Multiple Sites', if IQ3xcites are not set up to span routers, they will construct separate internetworks on subnets separated by routers.

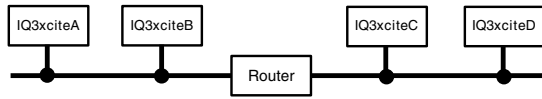

If several IQ3xcites are connected one side of a router, the unit with the lowest IP address will attempt to construct the network across the router. In the diagram, if the lowest address is IQ3xciteA it should be set up with the information for an IQ3xcite the other side, e.g.IQ3xciteC. IQ3xcite A will then join the internetworks across the router. If IQ3xciteC were to be switched off, the message from IQ3xciteA will no longer reach the remaining IQ3xcite on the far subnet (IQ3xciteD).

To prevent this, IQ3xciteD's details should also be entered in a remote Trend device module of IQ3xciteA so that it can connect to IQ3xciteD if IQ3xciteC is switched off.

*Note that an IQ3xcite set to 'Stand alone' mode by IP Tool will not attempt to build an internetwork across a router.*

**Internet Access:** Because the Internet uses TCP/IP addressing, the 963/IQ3xcite communication can operate over the Internet. Company Internet access is normally protected by a firewall which is usually the responsibility of the company's IT department. The firewall will need to be set up to allow messages through the port addresses being used for sending and receiving Trend messages. Additionally the firewall may be set up either to pass messages through or to redirect them. If redirection is being used, then the messages are sent to the firewall IP address and the firewall must be set up with the Trend IP address so it can pass them on. If using an impermanent ISP connection (e.g. via a dial up modem) at either 962 or IQ3xcite end, the ISP must support reverse dial up.

*Note that IQ3xcite to IQ3xcite networking communications will not operate across a firewall (i.e. virtual networks cannot be built across firewalls)*

**IQ3xcite with EINC:** The diagram below shows the addition of an EINC to Ethernet. The EINC supports a local Trend Lan which may contain IQ1 or IQ2 series controllers.

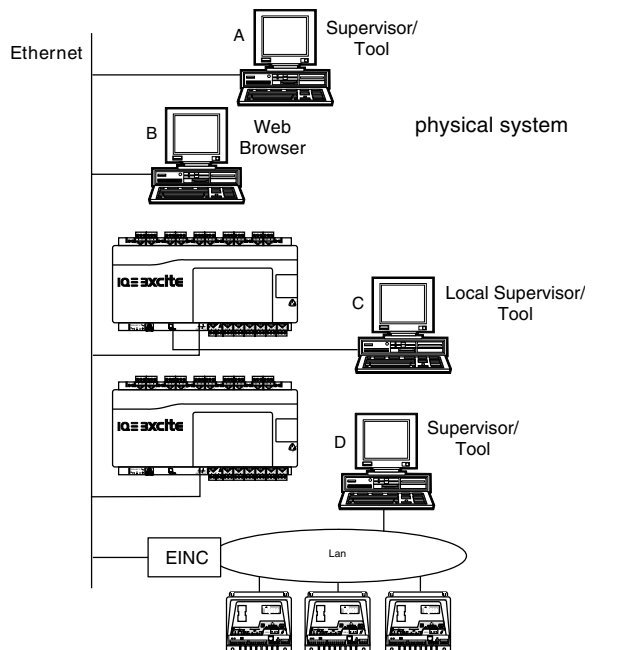

### System Configurations (continued)

#### IQ3xcite with EINC: (continued)

The diagram below shows the equivalent Trend network formed by the virtual networks.

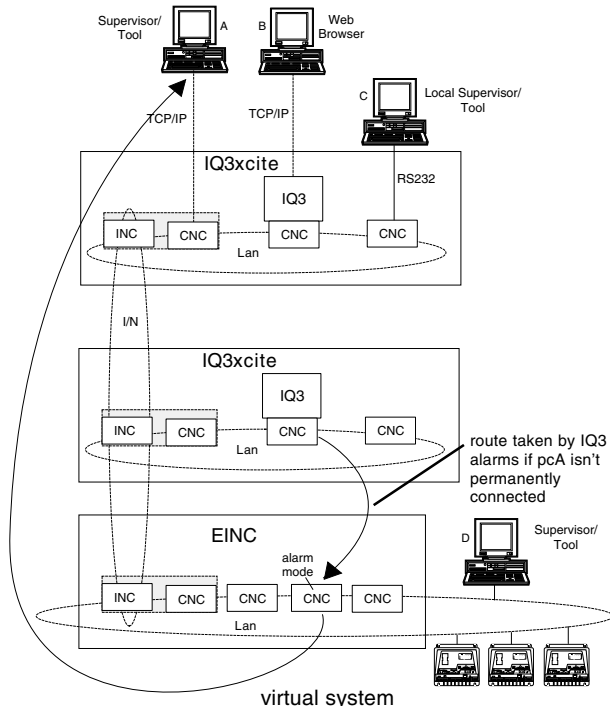

Now the two IQ3xcites can connect together along with the EINC via a virtual internetwork. The EINC also contains virtual CNCs which appear on its Lan together with the IQ2 series controllers and supervisor/software tool PC D. PC D can communicate with the IQ2s and IQ3xcites, and either controller types' alarms can be sent to PC D.



*Note that since both the IQ3xcite and EINC can contain a virtual INC, they cannot be on the same Lan (i.e. the local Lan setting in the IQ3xcite's address module must not be the same as the EINC's address switch setting).*

Since EINC's can also appear either side of a router, if there is a router separating the internetwork, EINC details must also be set up in the IQ3xcite remote Trend device module, and similarly IQ3xcite details must be set up in the EINC remote Trend device (i.e. remoteEinc) module. With reasonable risk two devices from each subnet could be used.

**It is recommended that the two lowest IP addresses (either EINC's or IQ3xcites) one side of a router have details of the two lowest IP addresses (either EINC's or IQ3xcites) on each subnet of the system the other side of the router.**



*Note that if an IQ3xcite is added to an existing system with EINC's either side of a router and has the lowest IP address then its virtual INC it will take over the responsibility of constructing the internetwork across the router and must have its remote Trend device modules set up; failure to do this will stop system communications across the router.*

PC A can now communicate with the IQ2's via the IQ3xcite's virtual CNC, as can PC C on the IQ3xcite's local port (as long as the CNC address is non-zero). However, the web browser, B, can only talk to the IQ3xcite (but its display pages could contain values from IQ2s obtained via IC Comms).

If PC A makes a permanent connection to the IQ3xcite's virtual CNC then the IQ3xcites' alarms may be sent to it, but if it makes a temporary connection (i.e. TCP/IP dial up) the IQ3xcites can send their alarms to the PC via the EINC. One of the EINC's virtual CNCs must be set to alarm mode and reserved for this purpose.

**IQ3xcite and TMN:** The IQ3xcite can use a TMN connected to an EINC's Trend current loop network. The EINC should operate in internetwork extension mode (i.e. device address =>100) which provides a Trend current loop internetwork with an extension on Ethernet. However, this will only give normal Trend Communications (i.e. text communications), it cannot provide web pages.

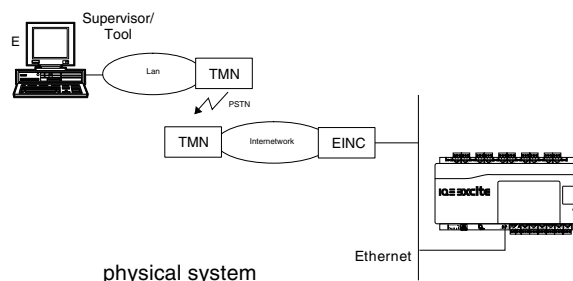

The diagram below shows the equivalent diagram showing Trend current loop networks and virtual networks.

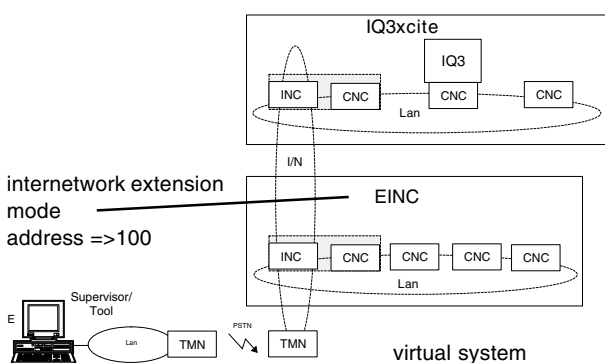

The internetwork now connects together the IQ3xcite, EINC and TMN. The autodialled supervisor or tool PC, E, is connected to the TMN by a Trend Lan.

#### Dial Up Networking:

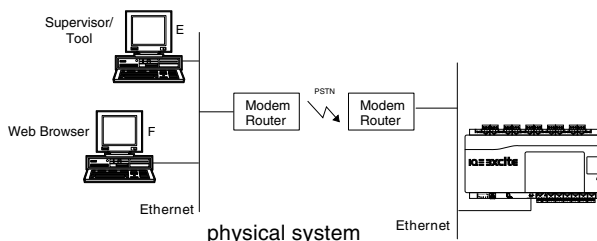

This method of communicating via PSTN connection makes use of modem routers. They connect together the segments of Ethernet via PSTN. They need to be programmed with the required telephone number and IP address in order to make the connection. This sort of connection can be used by a Supervisor/Tool or a Web browser as the connection becomes transparent to these devices as shown below in the equivalent virtual system diagram.

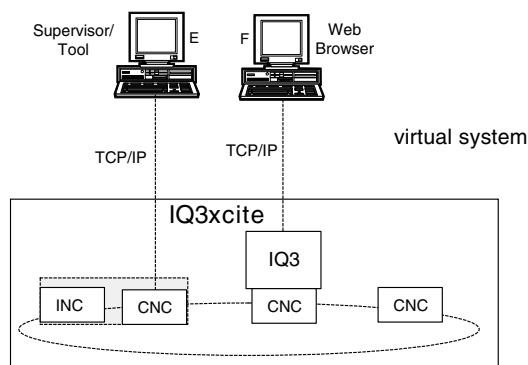

**HARDWARE**

**IQ3xcite**

**Box:** The controller box is DIN rail mounting and must be fitted inside a cabinet. The input channel links are accessible via a clear polycarbonate cover which can be unclipped using a screwdriver. The I/O bus connector has a hinged plastic cover. The auxiliary board cover can be levered off by inserting a screwdriver between the back of the cover and the main unit. It has a rear DIN rail clip.

The digital input and output LEDs and the three controller status LEDs can be viewed through the clear polycarbonate.

**I/O Bus:** This feature is only available on the expandable IQ3xcite. The IQ3xcite is connected to an adjacent I/O module by a rigid connector. It can be connected to a remote I/O module by a flexible cable. The connection is made by opening the flap, plugging in the connector, and then closing the flap over the cable. The last module on the I/O bus must be correctly terminated (see I/O Modules section). The IQ3xcite is provided with a terminator, and each I/O module is provided with a rigid interconnector).

**Connectors:** Two part connectors are used throughout to facilitate installation. The screw terminals are of a rising cage clamp type to facilitate good connections. Each input channel has a single part earthing terminal for cable screen connection. The internal cable screen earthing terminal bus is connected to the controller earth by a soldered link on the board. If required to segregate the screen earth from the controller mains earth, it may be connected to a separate external earth by lifting the cover and cutting the screen earth link; the internal screen bus terminal should then be connected to an external earth.

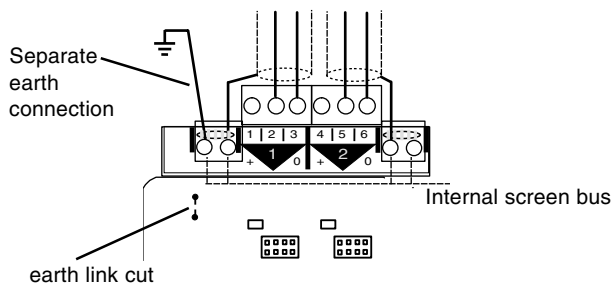

**Power Supply:** The IQ3xcite can be supplied with 100 to 240 Vac at 50 or 60 Hz. Power requirement is 23 VA maximum. *Note that a switch or circuit breaker must be included in the supply to the unit and in close proximity to it, and it must be clearly marked as the disconnecting device for the unit.*

**Fusing:** The 24 Vdc combined supply to the IQ3xcite's own I/O channels, the I/O bus, the RS232 connector (e.g. to power SDU-xcite), and the auxiliary supply output is protected by a self-resetting electronic circuit breaker. The part of the 24 Vdc combined supply which supplies the RS232, and the 24 V auxiliary supply output is limited to 150 mA.

The analogue output P bus is protected by a 1.6 A self resetting multifuse. The power supply is protected against catastrophic failure by a non-replaceable fuse. The analogue output circuitry is protected against the wrong connection of a non-isolated external supply by a non-replaceable fuse. If either non-replaceable fuse blows, the controller should be sent back for repair. The I/O modules have protection as described in the I/O module section.

**Battery Backup:** The strategy configuration and data (logs, alarms) are stored in the unit in nonvolatile memory (Flash). A 'supercap' is used to maintain the real time clock (time and date). In the event of power failure this will support the clock for 6 days (typically). Note that the supercap needs about 2 minutes to reach full charge after power is applied. Optionally a battery board (XCITE/BBC) can be fitted into the unit; this will support the clock for several years in the event of power failure (e.g. for Timemaster, see Firmware/Timemaster). If the battery hasn't been discharged, it should be replaced routinely every 5 years. The battery (type CR2032) can be replaced after turning the power off and removing the auxiliary board cover (while the battery is not in circuit the supercap will maintain the real time clock).

**Indicators:**

**I/O Channels**

**Input LEDs:** (yellow) All input channels have an LED to monitor the input state when the input channel is set to a digital input. The LED will illuminate when the associated input contact is closed.

**Output LEDs:** (yellow) Light intensity increases with output voltage.

**Core function**

**Watchdog** (🟡): (red) On if controller has a software fault (i.e. strategy or firmware).

**I/O bus error** (🔴): (red) On if there is an I/O bus fault, (e.g. check for short circuit between Data Hi or Data Lo and either of the power lines).

**Power** (🟢): (green) On when supply is connected. Flashes briefly at 1 second intervals if power supply fault; return unit to supplier.

**Ethernet**

**OK** : (green) Normally called LINK on Ethernet systems. ON indicates a good Ethernet connection. If OFF indicates faulty Ethernet connection.

**RX**: (yellow) Flashes when packet of data is being received across the Ethernet.

**24 Vdc Combined Supply:** The 24 Vdc combined supply supplies the IQ3xcite's own input/output channels, the I/O bus, the RS232 connector (e.g. to power SDU-xcite), and the 24 Vdc auxiliary supply output terminals. The total available current is 700 mA reducing to 550 mA for if the mains supply is less than 200 Vac. The PSU has thermal overload protection and the combined supply is protected by a self resetting electronic circuit breaker. The input and output channels are current limited at 22 mA each. The part of the combined supply used by the RS232 connector and the auxiliary supply is current limited to 150 mA (typical). The auxiliary supply can be linked into the P connector to supply auxiliary power for use by output devices.

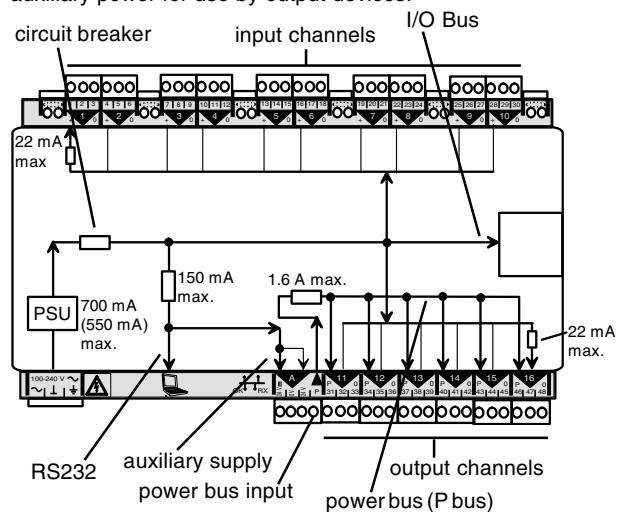

The P output terminals are used to supply the power to output devices. The internal power bus (P bus) is protected by a 1.6 self-resetting multifuse. The P bus can be externally supplied by an isolated 24 Vac/Vdc power supply, or can be supplied from the IQ3xcite 24 Vdc auxiliary output supply by fitting an external link. The controller is protected against the wrong connection of a non-isolated external supply by a non-replaceable fuse.

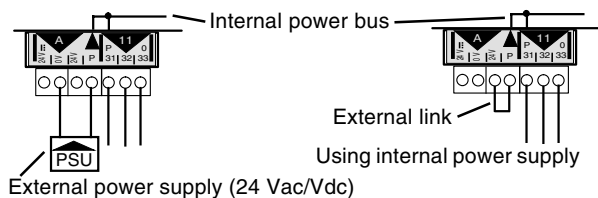

*Note that if an external 24 Vac/dc power supply is used, its output must be isolated from earth, and it must comply with the relevant EMC and safety standards*

The external supply can be either 24 Vac or 24 Vdc, but if the output devices require a mix of 24 Vac and 24 Vdc a decision will have to be made over which supply to connect to the P bus; the other supply will need to be provided by external wiring. *Note that the installer should note whether the P bus is 24 Vac, or 24 Vdc and only connect the appropriate loads.*

**IQ3xcite** (continued)

**24 Vdc Combined Supply:** (continued)

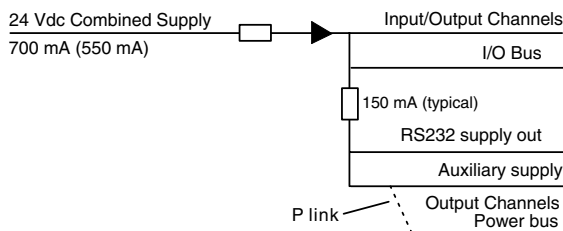

The following checks should be made:

- The maximum current 700 mA (550 mA) 24 Vdc combined supply is not exceeded.
- The 150 mA supply to the RS232 and Auxiliary supply is not exceeded.

The following areas of consumption need to be considered:

**Input/output Channels:** The universal input channels need only be considered if they are used for loop powered current,  $I_L$  in which case they consume a maximum of 20 mA each.

The output channels will also consume a maximum of 20 mA each, but their likely consumption is a lot less than this and can be calculated on an individual basis if necessary.

**I/O Bus:** The I/O bus supplies 24 Vdc through one of the bus terminals. This can be used to supply the adjacent I/O modules, or the I/O modules can be wired to an external power supply. If the main controller is used to supply any I/O modules their consumption must be considered in the auxiliary power calculation. I/O module power consumption is considered later.

**RS232 supply out:** The SDU-xcite consumes 15 mA.

**Auxiliary supply:** The 24 Vdc auxiliary supply terminals can be used to supply interfaces directly, and can also be linked to the P bus.

*Note that the 24 Vdc auxiliary supply voltage can drop to about 20.7 V under full load.*

**Output Channels Power Bus:** The P bus, which supplies the P terminals adjacent to the output channels, can be connected to an external supply, in which case the P bus consumes zero current from the auxiliary supply. If the P bus is linked to the auxiliary supply, the total current supplied from these terminals will have to be considered.

Item		Max current loading
I/O	Inputs T, V, D, I	0 mA
	Inputs $I_L$	20 mA per channel
	Outputs (V)	20 mA max. per channel, but can calculate individually
I/O Bus		Calculate each I/O module separately if supplied from main controller
RS232		SDU-xcite requires 15 mA
24 Vdc auxiliary supply	Auxiliary supply	Calculate consumption
	Linked to P bus	Calculate consumption if supplied from 24 Vdc auxiliary supply

Example: An IQ3xcite with an xcite/IO/4UI/4AO I/O module, SDU-xcite, and its own I/O as follows: 4 loop powered current inputs, 4 voltage inputs, 2 digital inputs, and 4 voltage outputs into 5 k $\Omega$  loads, 2 voltage outputs into 1 k $\Omega$  loads. The P bus is linked to the 24 V auxiliary supply and one of the P terminals supplies an A204P at 125 mA. The I/O module consumes 72 mA. What remaining auxiliary current is available?

**I/O Channels**

- 4 loop powered current inputs at 20 mA = 80 mA
- 4 voltage inputs = 0 mA
- 2 digital inputs = 0 mA
- 4 voltage outputs at (5 k $\Omega$  is 2 mA) = 8 mA
- 4 voltage outputs at (1 k $\Omega$  is 10 mA) = 40 mA

I/O bus module consumption	= 72 mA
RS232 SDU-xcite	= 15 mA
AUX supply out (linked to P bus)	= 125 mA
<b>Total</b>	<b>= 340 mA</b>

Since the unit is supplied at 230 Vac, the maximum 24 Vdc auxiliary current available is 700 mA. So remaining current available is 700-340 = 360 mA. This could be used by additional I/O modules.

If this were not sufficient an additional power supply could be used to supply the I/O modules (see I/O bus section below).

However, RS232/auxiliary supply consumption amounts to 140 mA (15+125); this is limited at 150 mA, so only 10 mA remains available from the 24 Vdc auxiliary supply terminals. If this is not sufficient an additional power supply could be used to supply the P bus as described above, releasing 125 mA for use by the 24 V auxiliary supply.

**I/O Channels:** The IQ3xcite has 10 universal inputs, and 6 analogue outputs. Additional I/O channels can be provided by connecting I/O modules to the I/O bus up to a maximum of 96 channels (expandable IQ3xcite, IQ3XCITE/96/.. only).

**Universal Inputs**

Channels 1 to 10 - linkable for digital (D), current (I), thermistor (T), or voltage (V) inputs.

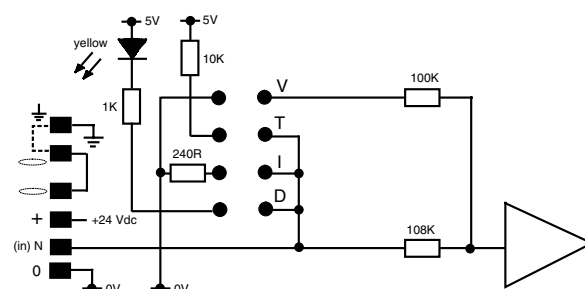

For D,  $I_x$ , V, and T connect between INn and 0 V.

For  $I_L$ , connect between 24 Vdc and INn.

Links:

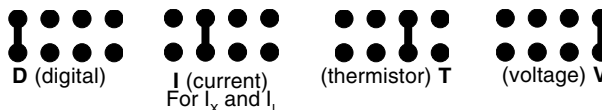

**Analogue Voltage Outputs**

Channels 11 to 16.

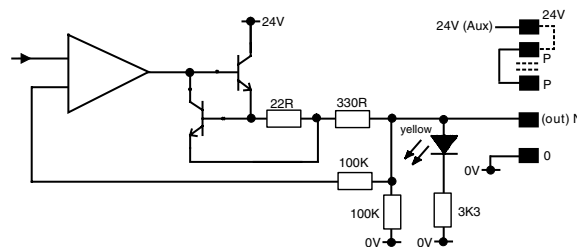

The P output terminals are used to supply power to the output devices. The internal power bus (P bus) is protected by a 1.6 A solid state self-resetting multifuse. The P bus can be externally supplied by an isolated 24 Vac/Vdc power supply, or can be supplied from the IQ3xcite 24 Vdc auxiliary output supply by fitting an external link as shown in the auxiliary supply section above. The controller is protected against the wrong connection of a non-isolated external supply by a non-replaceable fuse.

**Ethernet:** The controller should be connected to an Ethernet hub using Cat 5e unshielded or shielded (UTP or FTP) cable and RJ45 plugs (shielded or unshielded appropriate to the cable).

These are available from Trend:  
 CAT5E UTP LSZH 305M: 305 m of Cat 5e UTP (unshielded) cable  
 CAT5E FTP LSZH 305M: 305 m of Cat 5e FTP (shielded) cable  
 RJ45 PLUG UTP/10: Unshielded RJ45 connectors (pack of 10)  
 RJ45 PLU FTP/10: Shielded RJ45 connectors (pack of 10)  
 A local PC (Ethernet) can either be connected to an adjacent port on the hub, or can be connected directly to the IQ3xcite Ethernet port using a standard Ethernet cable in conjunction with a crossover adapter (XCITE/XA).

**HARDWARE** (continued)

**I/O Modules**

The expandable version of the IQ3xcite (IQ3XCITE/96/..) has the option of additional I/O modules connected via the I/O bus.

- A maximum of 15 I/O modules can be connected.
- A maximum of 96 points (16 points in the IQ3xcite and 80 expansion points) can be used.
- The controller and its I/O modules are to be fitted inside enclosures.
- No spurs are allowed on the I/O bus.
- If a single fully earth screened and bonded contiguous metal enclosure is used, then the total I/O bus cable length can be up to 30 m (this covers the use of a multiple section electrical control cabinet e.g. Form 4 enclosures). However, if any other type of enclosure is used, or the I/O bus runs between enclosures, then the total I/O bus cable length can be up to 10 m. (For the calculation of cable length, rigid interconnectors can be ignored.)
- Multiple enclosures must be earthed to a common earth point according to latest IEE regulations.

The current range of modules consists of:

- 8 Universal Inputs (/8UI/)
- 4 Universal Inputs (/4UI/)
- 4 Universal Inputs and 4 Analogue Voltage Outputs (/4UI/4AO)
- 2 Universal Inputs and 2 Analogue Voltage Outputs (2UI/2AO/)
- 8 Relay Outputs (/8DO/)
- 4 Relay Outputs (/4DO/)

**I/O Bus:** The I/O module has a hinged plastic cover each side for connection of the I/O bus, enabling the bus to be daisy chained by the I/O modules. A short rigid interconnector (XCITE/IC) is available for adjacent modules.

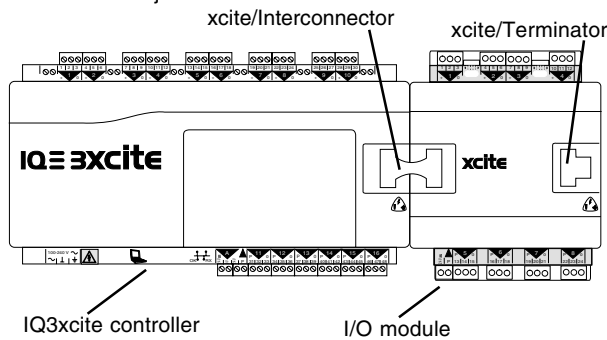

The bus should be terminated at the furthest end from the controller between Data Hi and Data Lo terminals with a 122 Ω resistor. A terminator is supplied with the controller, and spare terminators (XCITE/TERM/5 - pack of 5) are available from Trend.

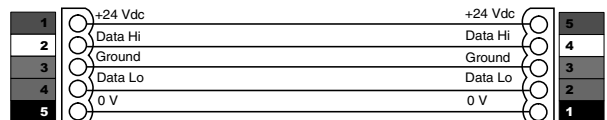

The rigid bus interconnector includes a ground connection.

For modules further apart within a metal enclosure, plug in screw terminals (XCITE/CC/10 - pack of 10) are available, enabling the modules to be wired together. Belden M3084A cable should be used, the ground connector should be earthed locally, and the cable screen should be grounded at the controller end.

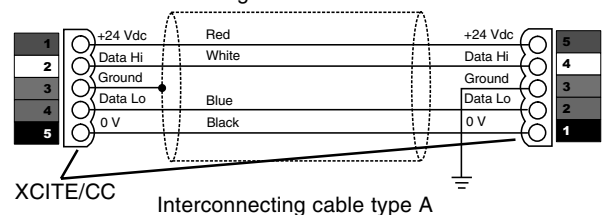

Note that the cable core colours shown are for the recommended cable, Belden M3084A.

This type of cable (type A) connects left hand side of one module to right hand side of another. It can be used for two sections of DIN rail in a panel as shown below:

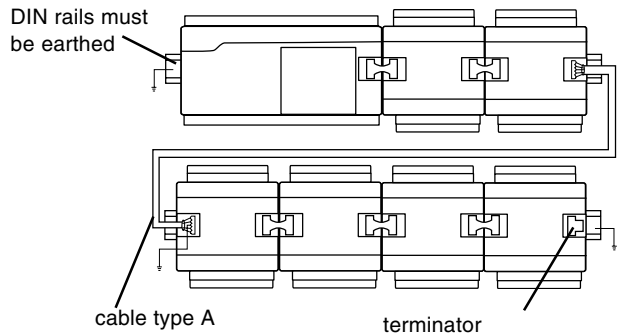

Use of cable type A to interconnect 2 sections of DIN rail

Interconnecting cable type B must be used if the connection is between the same side of each controller as one connector is rotated due to polarisation of the connectors. There are 2 types, right to right and left to left as shown below.

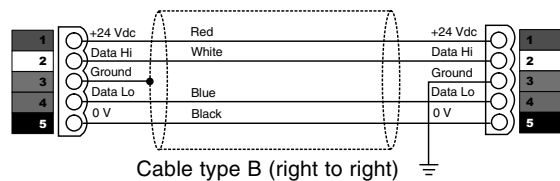
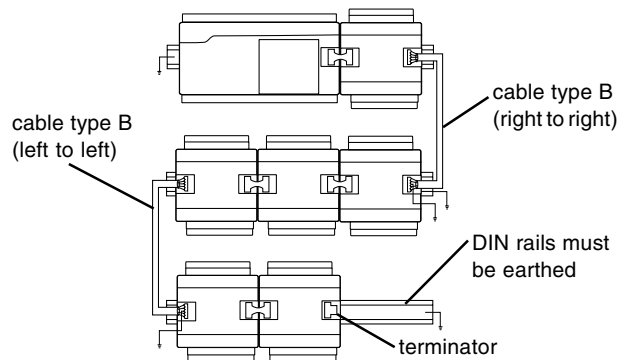

The diagram of cable type B (left to left) below shows the cable entry directions correctly, so the signal direction is reversed.

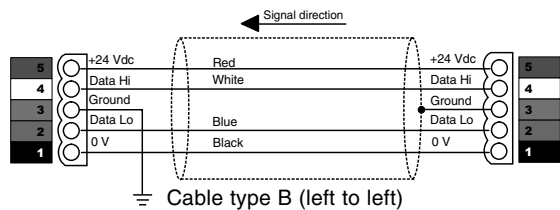

No spurs are allowed. For example, in the multisection panel below the DIN rail sections are connected in series to form one single length of bus with termination at the furthest end from the controller.

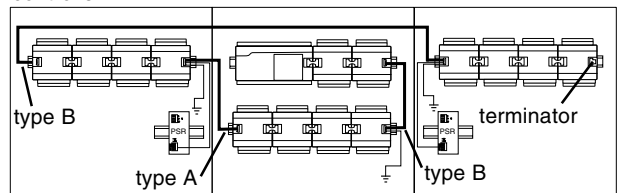

**Multisection panel with single length bus**

The IQ3xcite can supply 24 Vdc to the I/O modules via the I/O bus 24 Vdc terminal. The available current from the controller's combined 24 Vdc supply can be calculated as described above in the IQ3xcite/24 Vdc Combined Supply section.

Alternatively an external 24 Vdc supply must be used if:

- There are more than 6 I/O modules
  - The main controller combined supply would be overloaded.
- If an external supply is required, then a connection is not made between the 24 Vdc terminals, instead an isolated 24 Vdc supply is wired between the 24 Vdc and 0V terminals.

Note that if an external 24 Vdc power supply is used, its output must be isolated from earth, and it must comply with the relevant EMC and safety standards.



**I/O Modules** (continued)

**I/O Bus:** (continued)

For adjacent modules the XCITE/PCON/50 cable facilitates the connection of the external power supply; it leaves a 10 mm gap between the modules.

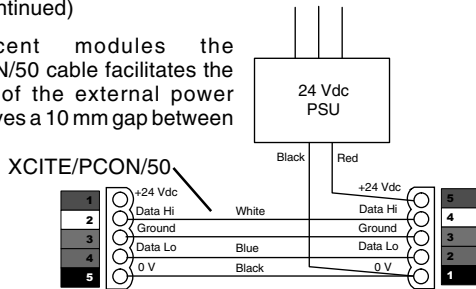

For non adjacent modules the following connections should be used (type A connection shown). This is facilitated by XCITE/PCON/1000, a 1 metre cable.

**Type A connection with external PSU**

XCITE/PCON/1000 (1000 mm cable)

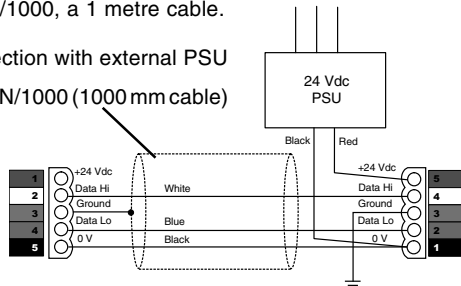

Trend can supply the PSR range of DIN rail mounted auxiliary power supplies (e.g. 1.3 A or 2.5 A). They have isolated outputs.

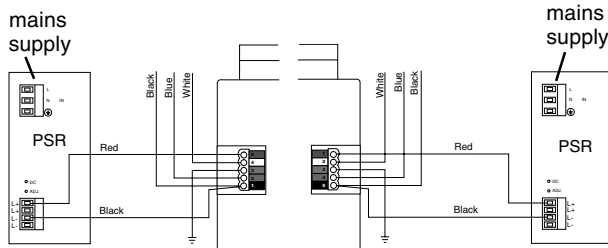

PSR connection to left side      PSR connection to right side

**I/O Module 24 Vdc Supply:** An I/O module can either take its supply from the main controller or from an external supply as described above.

An external supply must be used if more than 6 I/O modules are connected, or if the main controller combined 24 Vdc supply current were to be overloaded. This second condition depends on the total current consumed by the I/O module, and the current available from the main controller (calculated as described in the main controller auxiliary supply section above).

The I/O bus connector 24 Vdc terminal supplies the I/O module's core electronics, its input/output channels, and the 24 Vdc auxiliary supply terminal which is limited to 150 mA (typical). The auxiliary supply is provided so that it can be linked into the P connector to supply auxiliary power for use by output devices.

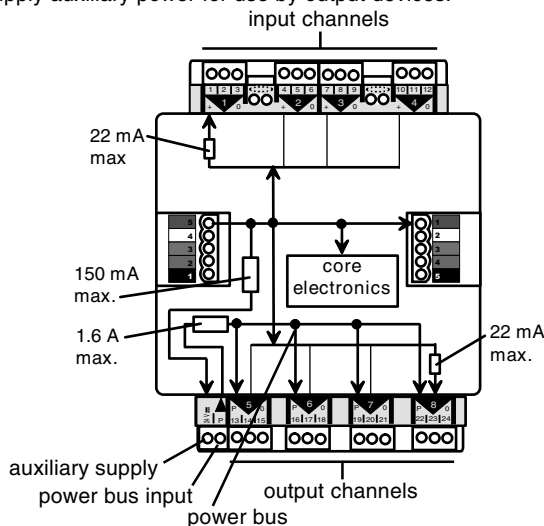

The maximum current consumed by the I/O modules is:

Mod.	mA	Mod.	mA	Mod.	mA
8DO	100	8UI	180	4UI/4AO	180 + Aux supply max 150
4DO	60	4UI	100	2UI/2AO	100 + Aux supply max 150

Just as for the main controller, on I/O modules with analogue outputs the P output terminals can be used to supply the power to output devices. The internal power bus (P bus) is protected by a 1.6 A self-resetting multifuse.

The P bus can be externally supplied by an isolated 24 Vac/Vdc power supply, or can be supplied from the I/O module's 24 Vdc auxiliary supply by fitting an external link. The I/O module is protected against the wrong connection of a non-isolated external supply by a non-replaceable fuse.

*Note that if an external 24 Vac/dc power supply is used, its output must be isolated from earth, and it must comply with the relevant EMC and safety standards.*

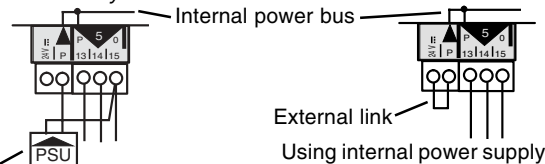

**Separate power supply (24 Vac/Vdc)**

The external supply can be either 24 V ac or 24 Vdc, but if the output devices require a mix of 24 Vac and 24 Vdc a decision will have to be made over which supply to connect to the P bus; the other supply will need to be provided by external wiring.

*Note that the installer should note whether the P bus is 24 Vac, or 24 Vdc and only connect the appropriate loads.*

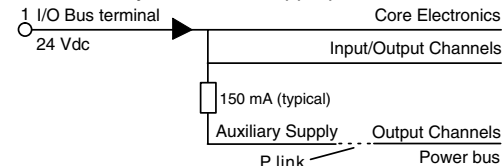

The following checks should be made:

- Calculate the maximum current consumed from the I/O bus 24 Vdc terminal for use in the main controller's auxiliary calculation.
- Check that the 150 mA supply to the Auxiliary Supply is not exceeded.

The following areas of consumption need to be considered:

**Core electronics:** 20 mA is required to supply the I/O module's electronics.

**Input/output Channels:** The universal **input channels** need only be considered if they are used for loop powered current,  $I_L$ , in which case they consume a maximum of 20 mA each. Each channel is individually current limited.

The **analogue output channels** require 3 mA each for their LED plus the output rated at 20 mA maximum, but their likely consumption is a lot less than this and can be calculated on an individual basis if necessary.

**Relay outputs** consume 10 mA each

**Output Channels Power Bus:** On I/O modules with analogue outputs, the P bus which supplies the P terminals adjacent to the output channels can be connected to an external supply, in which case there is zero consumption from the I/O bus 24 Vdc terminal to any output devices. If not, the total current supplied from these terminals will have to be taken into account.

Item	Max current loading	
I/O	Inputs T, V, D, I	0 mA
	Inputs $I_L$	20 mA per channel
	Analogue Outputs	23 mA max. per channel, but can be accumulated individually
	Relay Outputs	10 mA per channel
Core electronics	20 mA	
24 Vdc auxiliary supply	Linked to P bus	Calculate consumption if supplied from 24 Vdc auxiliary supply

Example: An xcite/IO/4UI/4AO I/O module has 2 digital inputs, and 2 external powered current inputs, and 4 voltage outputs into 1k $\Omega$  loads. The P bus is linked to the 24 V Auxiliary Supply and one of the P terminals supplies an A204P at 125 mA.

I/O Channels	
2 external powered current inputs	= 0 mA
2 digital inputs	= 0 mA
4 voltage outputs at (1 k $\Omega$ is 10 mA + 3mA)	= 52 mA
Core Electronics	= 20 mA
Auxiliary Supply out (linked to P bus)	= 125 mA
<b>Total</b>	<b>= 197 mA</b>

**I/O Modules (continued)**

The total consumption from the 24 Vdc supply terminal is 197 mA which should be considered when calculating the load on the main controller's auxiliary supply. If the main controller cannot supply this current, an external 24 Vdc supply should be connected to supply the I/O module.

The Auxiliary Supply consumption amounts to 125 mA; this is limited at 150 mA, so 25 mA remains available from the 24 Vdc Auxiliary Supply terminal. If this were to exceed the 150 mA limit, an additional power supply should be used to supply the P bus as described above.

*Note that the 24 Vdc auxiliary out supply is normally about 19.8 V and will drop to about 18.4 V under full load.*

**Screen Earthing:** On I/O modules with analogue inputs, the screens for analogue input channels are normally connected to the module ground, but they may be separately earthed (if required to segregate the screen earth from the I/O module ground). This is similar to the controller screen earthing, see IQ3xcite, connectors section. There is a separate link for each group of four channels (i.e. the 8 universal input module has two links).

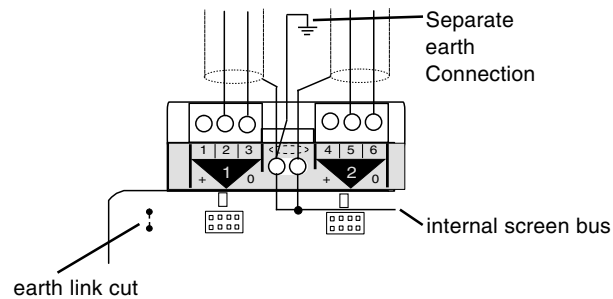

**I/O Module Enclosure:** The I/O module enclosure is DIN rail mounting and must be installed in a cabinet. It has clear polycarbonate covers over both the upper and lower terminal sets to enable access to the channel links and the address switch. The strips can be unclipped using a screwdriver and clipped back

**I/O Module Range:**

**8 Channels**

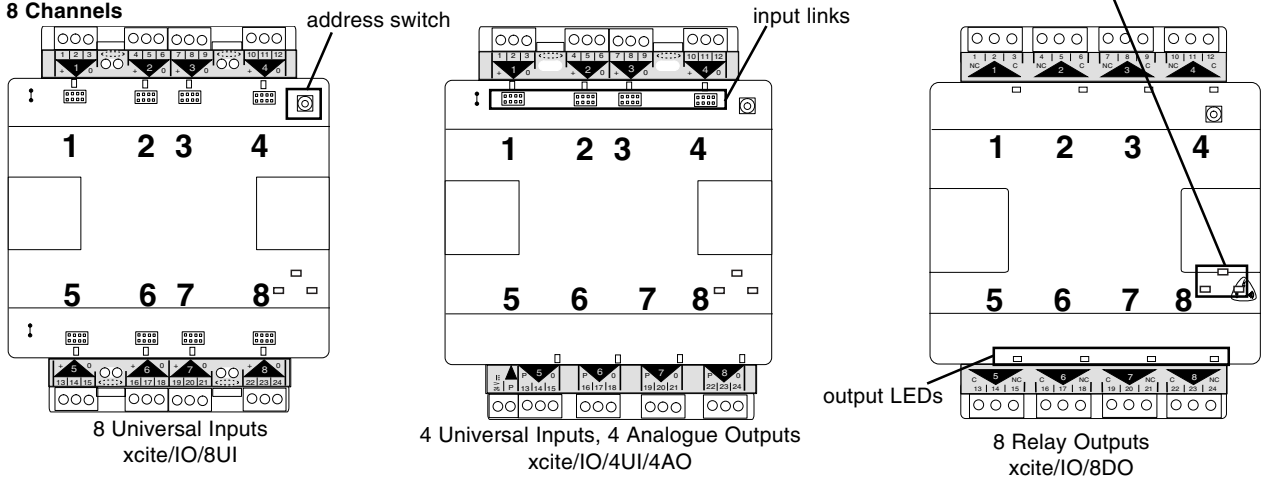

**4 Channels**

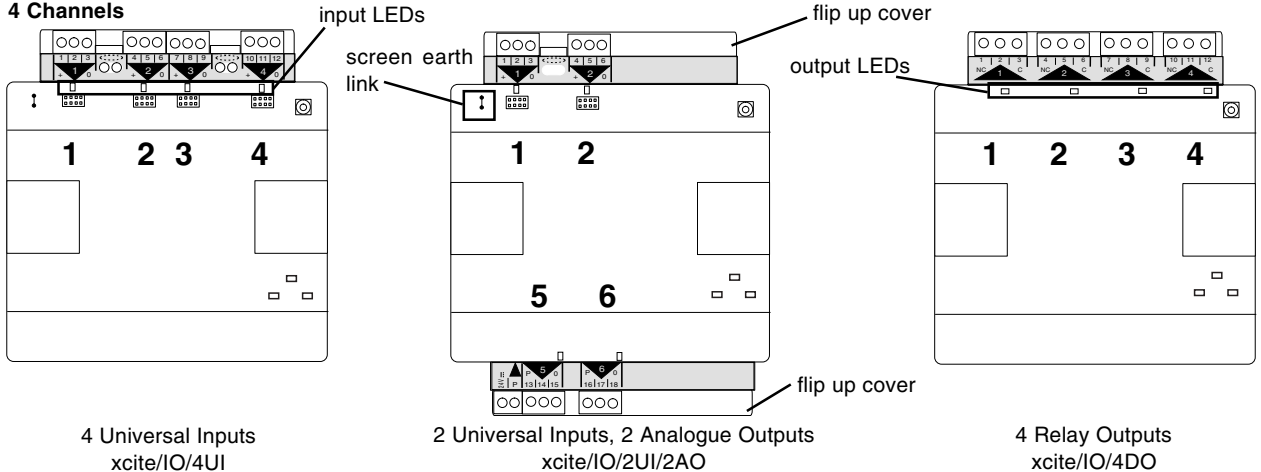

in position after use. The I/O terminals are protected by clear polycarbonate flip up safety covers. It has a rear DIN rail clip. The digital input and output LEDs and the three controller status LEDs can be viewed through the clear polycarbonate.

**I/O Module Address Switch:** The address switch consists of a hexadecimal switch, 0 to 9, A, B, C, D, E, F. Selecting address zero disables the module. If there is an address clash on the I/O bus, the I/O bus fault LEDs on all the modules with the same address will flash; a module's address can be corrected by setting its address switch to other addresses until its LED stops flashing. When setting up the input and output channels in sensor, digital input, and driver software strategy modules, the I/O module address and the channel number have to be entered; the main controller is referred to as module zero.

**I/O Module Channels:** The universal input and analogue output channels have similar connections to the main IQ3xcite. The analogue outputs have a similar arrangement to the main controller with the 24 Vdc auxiliary output supply (limited at 150 mA) and the P bus.

The relay outputs are single pole changeover, and have a relay output status LED (yellow) which is ON when the relay is energised.

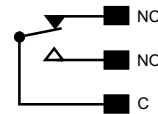

**Indicators:** The I/O modules have similar indicators to the controller: Digital input, Analogue output, Relay output (see above), Power, and Watchdog.

The I/O Bus LED will illuminate continuously for an I/O bus fault (e.g. check for short circuit between Data Hi or Data Lo and either of the power lines). If the LED flashes at 1 second intervals, the I/O module has not been in receipt of any valid comms for 30 secs, and the module will switch off any outputs. If the LED flashes faster it indicates an address clash as described above (I/O Module Address Switch).

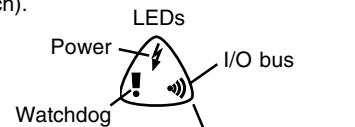

## FIRMWARE

The IQ3xcite strategy modules are based on the traditional IQ paradigm with minor changes to increase capability and efficiency. The .IQ3 strategy file can be created using SET and downloaded via Ethernet (FTP). This requires the PC running SET to be connected to Ethernet, and to communicate with the IQ3xcite using the IQ3xcite's IP address (SET will actually obtain the IP address from the IQ3xcite using the Trend Lan number and device addresses). The .IQ3 strategy file can be backed up in the same way.

A local PC (Ethernet) can either be connected to an adjacent port on the hub, or can be connected directly to the IQ3xcite Ethernet port using a standard Ethernet cable in conjunction with a crossover adapter (XCITE/XA).

The IQ3xcite web server provides pages (HTML) which enable limited configuration from a web browser; most module parameters may be viewed and adjusted, but the strategy structure (module interconnections, creation or deletion of a module) cannot be modified from a web browser.

## Addressing

Each IQ3xcite has a unique MAC (Media Access Control) address allocated to its Ethernet node. The IP Tool (SET auxiliary application) enables the IQ3xcite IP address (and other Ethernet parameters), and the Trend Lan number and device address to be set up. This requires the PC running SET and the IP Tool to be connected to Ethernet as described above. The IP Tool can automatically fetch the details of all the Trend IP devices (EINCs and IQ3xcites) on its own segment of Ethernet; it can also fetch details from devices the other side of a router by reading the remote Trend Device modules from an IQ3xcite or EINC if the user enters the remote device's IP address (alternatively the user can enter the details by hand).

The IP Tool also enables the Virtual CNCs to be configured, and for the IQ3xcite to be set stand alone if required. *Note that for a controller in stand-alone mode, if a working Ethernet connection is not made, the RS232 communications (e.g. SDU-xcite) may not operate until about 10 mins after power up.*

## Strategy Modules

The IQ3xcite strategy modules include the following IQ2 modules:

Type (sensor type), Sensor, Digital input, Function, Logic, Loop, Sequence table, Knob, Switch, Time, Zone, OSS, User, Address, IC Comms, Alarm history, Plots, Time zone exceptions (partial implementation of Calendars), Display and Directory modules, Driver, page, group, route, destination.

Although the analogue and digital arrays are not included, the new analogue modules and digital byte modules can be used for IC Comms and to support IQ2 strategies. (Also not included are: Schedules, Critical alarms, Autodialling modules, and Calendars other than time zone exceptions.)

The following features indicate the differences between IQ3xcite and IQ2 modules:

**Longer labels:** Module labels will now have a maximum of 30 characters, although to maintain backwards compatibility, in some circumstances only 20 may be used (e.g. only 20 characters retained in the alarm log). If using an SDU-xcite, the label length must be limited to 20 characters; if longer the SDU may fail to operate.

**Plot:** The IQ3xcite logs will have 8 digit resolution. However, the first release IQ3xcite can only use existing communications protocol which limits the resolution to 5 digits.

**Time Zones:** The time zone has a normal week (standard week), and exceptions. The exceptions are the IQ3xcite equivalent of IQ2xx calendars and enable dates to be set up with different occupation times (see Web Pages, Time Zones)

**User module:** The user module is extended to include security for web access. There are Name (30 characters) and Password (30 characters) parameters. The module also a Home page (URL) that can be defined for each user.

**Flexible module numbers:** The number of each type of module may be adjusted to match the requirements of the application as long as the memory capacity of the controller is not exceeded. As a general guideline the IQ3xcite has at least equal capacity as a fully utilised IQ251.

The available capacity is measured in brIQs. The total available capacity in the IQ3xcite is 30000 brIQs. Each type of module has memory requirement in brIQs as listed below:

Category	Module	Size (brIQs)
Alarm modules	Group	9
	Route	9
	Destination	14
Control Modules	Function#	19
	Exceptions*	13
	IC Comms#	19
	Logic#	19
	Loop	55
	Node#	16
	OSS	34
	Sensor type	12
	Driver#	57
	Digital input#	28
	Knob	13
	Sequence	106
	Sensor#	76
	Switch	10
	Time Module	38
Time Zone*	566	
General Modules	Virtual CNC	9
	Address	24
	Hardware I/O modules	14
	Page	4
Display Modules	Plots	12
	Directory	13
	Display	19
	User	12

Notes:

# The actual size in (numbers of brIQs) varies with module type. The largest size is shown here.

\* The time zone size includes 20 exceptions. If more are required they require 13 brIQs each.

In SET, as the modules are created, a tally is kept of the brIQs used and the amount available to be used; an indication of this can be viewed. If the limit is exceeded, then SET will prohibit the creation of further modules.

It is possible to create modules which are not numerically sequential so module lists can be non-continuous (e.g. L1, L2, L5, L7...)

**FIRMWARE** (continued)

**Direct module interconnection:** Modules are no longer connected via nodes but are connected directly to each other. Thus each module input is set up with a connection to its source. In SET this is done graphically by dragging a connection between the modules.

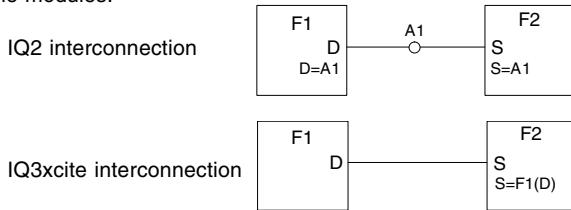

Module parameters are either inputs, outputs, or internal parameters.

Analogue and digital array nodes that were effectively module inputs and outputs (e.g. sensor alarm bits) are now module inputs and outputs in their own right.

In the webpages modules' details (see later), the source connection is shown against an input. All an output's destinations are also shown, having been determined by the controller firmware. If nodes are required to upgrade an IQ2 strategy to IQ3xcite, analogue modules and digital byte modules will have to be created by the user after conversion (see IC Communications below). Nodes which were read/write now have inputs and outputs (e.g. knobs now have input, V, value). Multiplexing of nodes is achieved by allowing many module outputs to connect to one module input. All IQ3xcite module inputs have a value as well as a connection. So a constant input is achieved by setting the value, and not setting the connection. An input which is to be ignored (e.g. an input to an averaging function module) has its value deleted (as opposed to a zero value, which is valid); in SET this is set by a tick box on the input.

**Event driven strategy:** Normally modules will be entered in the **sequence table** like IQ2 modules. There is an absolute maximum of 600 modules per second (i.e. 600 modules in the sequence table with a 1 s cycle time).

However, a section of strategy may be **event driven** where the values travel through the interconnected modules from one end to the other. This is used to replace the 'fast digital inputs' feature available in IQ2. A module is set to be event driven by taking it out of the sequence table using SET.

An event is defined as a change on the input to an event driven module. Counting both sequence table modules and events as 'items', there can be up to 900 items serviced per second of which up to 600 can be sequence table modules.

*Note that event driven strategies cannot include feedback (i.e. a connection from an output back into an input of a preceding module). This will cause the section to become non event driven.*

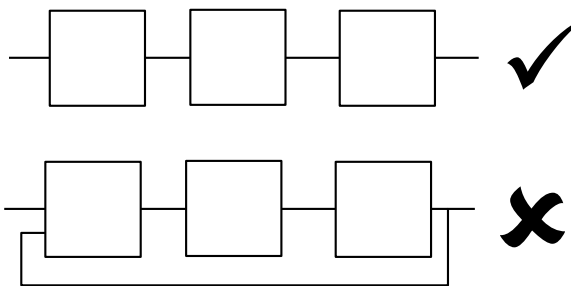

Event driven strategy with feedback

*A strategy that includes feedback with 'fan out' (i.e. which create two output events for one input event) would cause the 600 module/s limit to be exceeded, and would generate a 'Sequence Table Overrun' alarm. The section becomes non-event driven.*

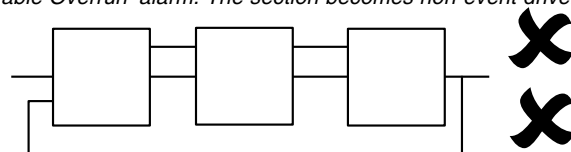

Event driven strategy with feedback and fan out

Any module which is sequenced or event driven may be disabled (e.g. for commissioning purposes) setting its disable parameter 'on'.

**IC Communications:** The IQ3xcites may communicate with each other and IQ2 (and IQL) controllers using Inter Controller Communications (peer to peer communications) using Trend Lan/node addressing (not direct IP addressing).

IC Comms Type		Configured in IQ2 to IQ3xcite	Configured in IQ3xcite to IQ2	Configured in IQ3xcite to IQ3xcite
Data From	Digital Bit or Byte	No	No	No
	Analogue	No	No	No
Data To	Digital Byte	Yes	No	No
	Analogue or Digital Bit	Yes	Yes	Yes
Global To	Digital Byte	Yes	No	No
	Analogue or Digital Bit, and Item Attribute Match	Yes	Yes	Yes
Visitor Comms (max, min, sum, average)		No	Yes	No

**Comms from IQ2s:** IQ3xcites will respond to all Data to and Global to comms excluding visitor comms.

**Comms to IQ2s:** IQ3xcites can send Data to, and Global to including visitor comms, but digital bytes and Data from comms are excluded.

**Comms between IQ3xcites:** Data to, Global to but digital bytes, visitor comms and Data from are excluded.

The receipt of IC Comms with an analog node or digital bit/byte is implemented by creating analogue node or digital byte modules during the strategy creation process on SET.

**Alarms:** The IQ3xcite has no critical alarms. Item alarms are as for IQ2, but there are additional general alarms as indicated in the Address module section below. Network alarms are the same as IQ2 but are only sent to the local supervisor port.

Item and general alarms may still be sent in coded, text alarm, or attribute format. The 'roll round' alarm log has a maximum length of 50 alarms after which the earliest alarms are lost.

**Alarm bits:** As explained above the sensor alarms bits are outputs from the sensor module. They also accompany the analogue value so that for example as the value passes through a function module it can take the correct action on input failure.

**Timemaster:** Timemaster functionality is different from IQ2 as it is a separate parameter (Timemaster on or off ) as opposed to being switched on by 'daylight hours change' parameter in IQ2. The time synchronisation message is now a global/global text comms message which will synchronise all IQ1 (post 1989), IQ2 and IQL controllers. The IQ3xcite does not provide the time keeper functionality; this was only required for IQ90's which did not have a battery backed real time clock, and they should be supported by a pre-IQ3 timekeeper controller on their own Lan.

The IQ3xcite real time clock is able to ascertain if it has lost its time synchronisation due to the supercap discharging after a power fail, and if so the controller will request time synchronisation from the timemaster.

*Note that an IQ2 controller will not respond to this request so on a combined system (IQ3xcites with other IQs) an IQ3xcite must be the timemaster.*

The supercap support for the clock will expire after about 6 days (typically) of power failure, so a system of IQ3xcites would need re-synchronising after this time. The timemaster IQ3xcite should be fitted with the battery option board which would support the clock for about 6 months.

**FIRMWARE** (continued)

**I/O Module:** An I/O configuration module has to be created for each hardware I/O module connected to the I/O bus. The I/O configuration module number is the same as the address of the hardware module on the bus (i.e. I/O configuration module 2 is for hardware module at address 2).

In SET the module is set up by selecting Device/I/O setup and entering the ID (address) and type.

**Display and Directory Modules:** These are used to generate the IQ3xcite display pages as described in the Web Pages, GraphIQs section below.

**Address Module:** The address module has additional parameters for Ethernet communication. These are described in the rest of the document loosely as IP address. See Trend Ethernet Products Engineering Manual TE200369 for details.

**IP address:** (read/write, default 128.1.1.3) The IP (internet protocol) address of the controller. Must be unique. It is normally specified by the persons responsible for the IT system.

**Subnet Mask:** (read/write, default 0.0.0.0) The mask used to mask the IP address to produce a subnet. All IQ3xcite's and EINC's must be on the same subnet (and hence have the same subnet mask) in order to construct a Lan or Internetwork. IQ3xcites on the other side of a router may have a different subnet mask.

**UDP port:** (read/write, default 57612) The UDP (User Datagram Protocol) port defines the IP port used by the IQ3xcite. All the IQ3xcites and EINC's used to create Lans and an Internetwork must use the same UDP port number. IQ3xcites and EINC's can be set up with different UDP ports to create two completely separate systems on the same subnet.

**Router 1:** (read/write, default 255.255.255.255) This specifies the IP address of a router to which messages are sent if the destination address is not on the local subnet. It should be set to the IP address of a router on the same subnet as the controller.

*Note that IP address, Subnet mask, UDP port, Router 1 are normally configured by IP Tool.*

**External I/O Limit:** (read only) The maximum number of external channels that may be connected (i.e. 0 or 80).

**External I/O count:** (read only) The current number of external channels connected.

**Strategy Memory Size:** (read only) The total strategy memory in the current controller (may change with firmware version etc.).

**Strategy Memory Used:** (read only) The amount of memory used for the current strategy

**Additional General Alarms:**

**Sequence Table Overrun:** The controller is unable to complete the sequence of modules in the require time. Reduce the number of modules.

**Low RAM:** If the controller runs low on RAM it will send this alarm and reboot. Contact Trend Technical Support.

**I/O Bus Failure:** Communications failure on the I/O bus (e.g. short circuit). Check wiring.

**Low Flash:** The amount of memory used by graphics files (backdrops) is excessive. Reduce the size or number of files.

**Archive Failure:** The archiving of the running strategy file into flash memory has failed. Contact Trend Technical Support

**Corrupt Time:** Similar to standard Fail RTC alarm

**Virtual CNC:** The virtual CNC enables supervisors or software tools to connect to the IQ3xcite via Ethernet using text comms and I/P addressing. It is set up in IP Tool. It has the following parameters:

**Address:** The device address of the virtual CNC on the IQ3xcite's Lan. It must be unique on that Lan.

**Port Number:** The port number attached to the CNC. Since the virtual CNC and the IQ3xcite are on the same IP address, they need different port numbers; the IQ3xcite uses port 80 (standard for web browsers), and the virtual CNC needs to be set to a port number suitable for the IT system.

**Remote Trend Device:** The remote Trend device module contains a remote device's IP address and subnet mask. There is a list of 20 remote Trend devices, which is set up by IP Tool. The list must be set up in order to allow the Trend virtual networks on Ethernet to span routers as explained in the System Configuration section.

**Device Mode:** This enables the IQ3xcite to be set to stand alone mode which is described in the System Configuration section. When the IQ3xcite leaves the factory it is set to 'unconfigured' mode. The first write to the IQ3xcite, (e.g. by IP Tool to set the IP address) will set it to 'networked' mode. It can then be set to stand alone mode by IP Tool.

**Web Pages**

The web pages all have a menu bar across the top of the page with the following selections: Login\*, Alarms, Time Zones, Modules, GraphIQs. (\*Login changes to Logout once the user has logged in).



Standard web pages are provided to support all the selections except for the 'GraphIQs' which depend on the configuration of the display and directory modules.

Selecting 'Modules' produces the module selection buttons down the left hand side of the page from which the module's list page may be selected. This lists all the modules of that type, and by selecting a particular module, its details page may be viewed. On the details page the module parameters may be viewed or changed.

**Welcome Page:** A fresh user coming into the IQ3xcite 'website' will be given the status of 'system guest' and the password user level of 100 which gives total access.

However, if there are any users set up (i.e. the IQ3xcite's security is enabled), then the 'system guest' user level will be -1, which allows the module details and parameters to be viewed but not adjusted.

If the 'guest' user has been set up without a password, then the fresh user will be given the status of 'guest' with the level as set for 'guest user'.

**Login:** The user may select Login from the menu bar.

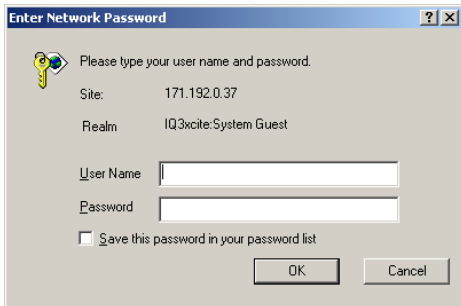

The User Name and Password should be entered. These must correspond to those set up in a user module. The user module defines the user level (i.e. what can be changed), and the home page for that user. If the home page is set up, it will be displayed once the OK button is pressed after a valid user name and password are entered. The home page can be one of the directory pages, which in the IQ3xcite can be graphical display pages, and the directory pages can be linked to allow navigation; the home page could also be any other HTML page (e.g. any of the standard IQ3xcite pages, or a company website). Once the user has logged in, the Login selection changes to Logout. The user should logout and close the browser after completing a session in order to preserve security. It is possible to let the browser store the name and password so that the user need not log in on re-entry to the IQ3xcite website, but this must be done with care so as not to impair the password security.

**Alarms:** The user may select Alarms from the menu bar.

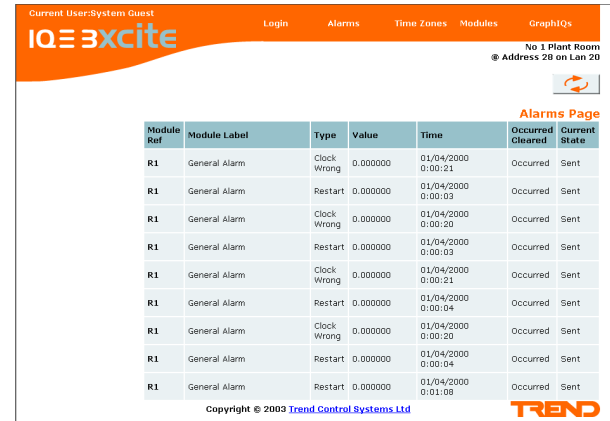

The alarm log gives a list of the basic alarm attributes from the alarm log. It gives the source module reference (e.g. S1, sensor 1), and its label, the type of alarm (e.g. high), the value at the time of alarm, the time (time and date), the reported state (occurred or cleared), and the current state of the alarm message (whether it is active or completed). Clicking on Module Ref will display the source module details.

**Time Zones:** The time zone selection gives the list of time zones.



The zones are listed together with the label, the current state (O=unoccupied, I = occupied), and hot links to the normal week and exceptions.

Selecting the normal week enables the individual days to be set up and copied from one to the other. Additional occupation periods can be added to a day. Note that to create a period, two time zone change times should be added, one to switch occupation on, and one to switch it off.

Selecting the exceptions enables exceptions to the normal week to be set up (these correspond to the IQ2 calendars). An exception day can have a number of start/stop times set up and can have a start date and stop date. The exception day can either be set to off, or to the next occurrence of start /stop date only (after which it will set itself off), or to every occurrence of the start/stop dates (i.e. off, next, every). Each exception also has a priority level (1-top to 6 -bottom) so that if exceptions clash, the highest priority wins.

**Web Pages** (continued)

**Modules:** Selecting Modules from the menu bar produces the module selection buttons down the left hand side of the screen.



The actual module buttons shown depend on the current password level. (A password with level 80 or above will give a full list of module types). Clicking on a module button will produce a list of the modules of that type which enables a module to be selected to view its parameters, and, if authorised, to change them.

*Note that access via the web pages only enables the module's details to be changed; changes to the strategy structure (i.e. module interconnections, and creation/deletion of modules) can only be done via text comms or via a strategy download (e.g. using SET).*

**Module List:** The list of modules shows all the instances of that module type that have been created.

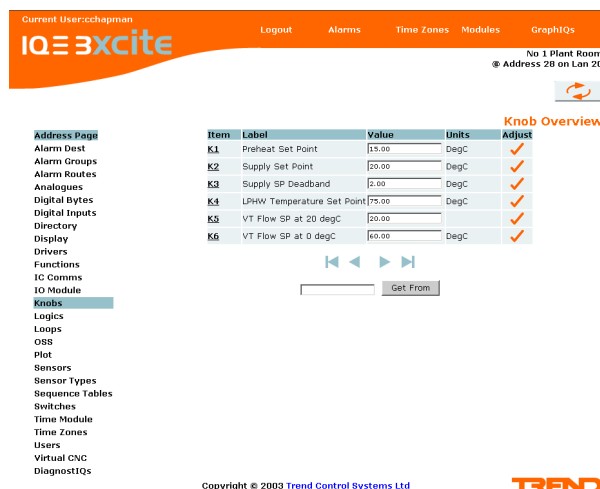

In the case of adjustment modules (i.e. knobs and switches), the value/status can be changed (i.e. by 'wipe and type') and the change implemented by clicking on the tick icon, ✓.

On both module lists and module details pages, the refresh icon (top right hand corner) causes the values to be refreshed, and the graph icon (adjacent to the appropriate value) allows the graph page to be viewed. Clicking on a module from the list displays the module's details page.

**Module Details:** The module details page allows all the module parameters to be viewed, and the parameters to be changed (other than those that refer to module interconnections).

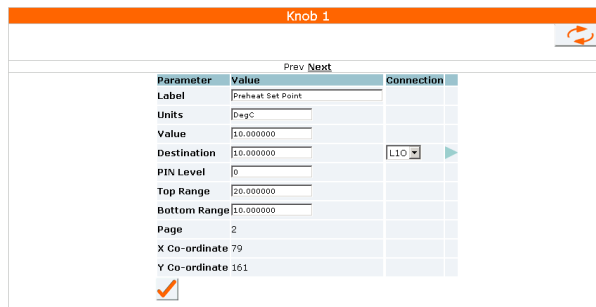

In the case of the knob, the label, value, units, PIN level, and top and bottom of range can be changed, but the destination, page, and x, y coordinates cannot be changed.

Module destinations and sources can be clicked on to jump to the details page of the destination or source module. This is done by clicking on the connection arrow, but for destinations, the particular destination can be selected from a drop down list before selecting the arrow.

**Graph Page:** The graph page gives a graph of the values in the plot module, and a spot value which can be moved along the graph trace.

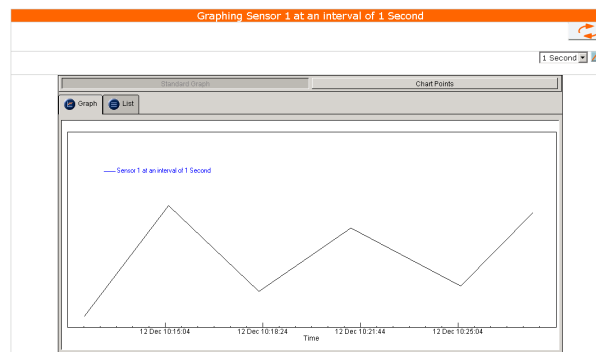

The list of values used to create the graph can be seen by selecting the list tab. As the point is moved along the graph its point value is displayed. A section of graph can be enlarged by the zoom feature (left click and drag, right click to reset). The graph display can also chart (display a graph of live values as they occur).

**DiagnostIQs:** The diagnostIQ pages give useful diagnostic information to enable a Trend engineer to diagnose a fault.

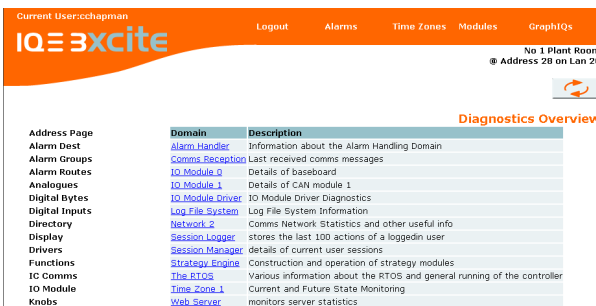

**Web Pages** (continued)

**GraphIQs:** Selecting GraphIQs from the menu bar will display the first graphical display page. A directory 'navigator' in the top left hand corner facilitates moving from page to page.

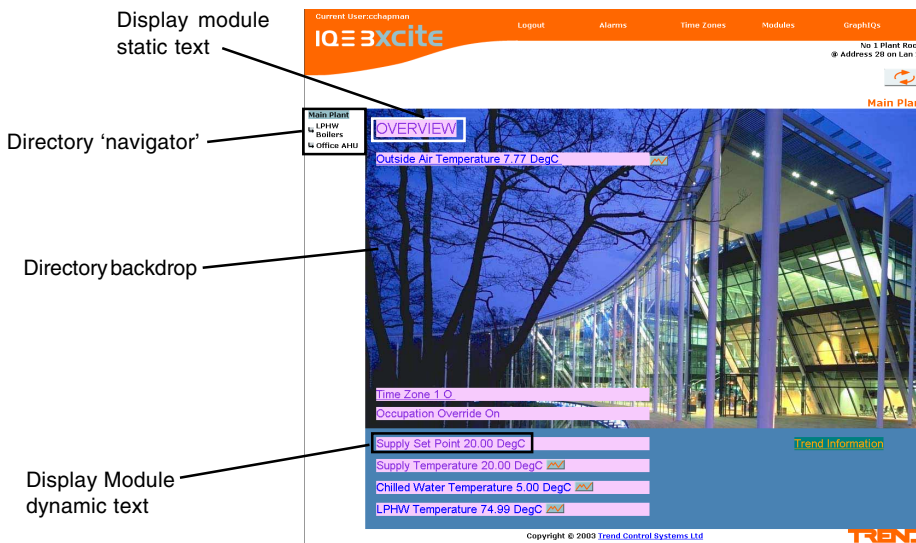

The IQ3xcite graphical display pages are based around the Display and Directory modules' structure. The directory module can have a graphical backdrop onto which the display modules' text can be placed. The display modules have x and y coordinate parameters which enable them to be located at appropriate points in front of the backdrop.

The directory navigator is automatically generated and placed in the top left hand corner. The current page displayed is highlighted, and the page above (parent), those on the same level (siblings), and those below it (children) in the hierarchy are also shown.

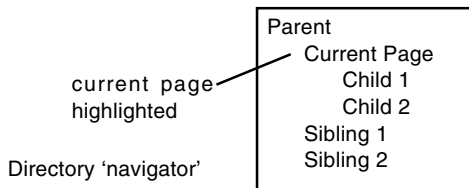

The pages are entered in SET, the backdrop being imported into SET as a graphical file.

**Directory Modules:** The directory module has a backdrop parameter which defines the filename of the graphical file (bitmap, e.g. .jpg, .gif, .bmp, .png). An additional backcolour parameter defines a colour to be used as background if there is no backdrop or the browser cannot access the picture. The dynamic items are automatically refreshed and the refresh rate can be defined.

**Display Modules:** As well as x, y coordinates the display modules have a type parameter which can be set to either static or dynamic text.

Static text has the following parameters:

- Label : The displayed text.
- Forecolour/Backcolour: The text colour and its background colour which can be transparent.
- Fontname and font size: The font can be either Serif, Sans-serif, Cursive, Monospace, or Verdana and its size is specified in points.
- Width and textalign: The width can be constrained or auto sized, and it can be aligned left, centre, or right.
- URL: The text can have an internet link under it so when it is selected the browser will jump to that URL (i.e. another website which could be another IQ3xcite controller).

Dynamic text has the following parameters:

Item: The text comms code for the dynamic parameters to be displayed.  
e.g.

- S1 Sensor 1 label, value, units
- S1V Sensor 1 value
- W1 Switch 1 label, status
- W1S Switch 1 status
- Z1 Time zone 1 label, state
- RL Label from Address module (also RD identifier, RN Lan number)

Forecolour/Backcolour, Fontname and font size, Width and textalign: as for static text

InAlarmcolour: Alternative foreground colour to be used if item is in alarm

Clickable: This specifies whether or not there is a link to the module details page for this item

**FIELD MAINTENANCE**

The IQ3xcite Controller requires virtually no routine maintenance, however it is recommended that if the battery option board is fitted, the battery should be replaced every 5 years, as explained in the IQ3xcite Installation Instructions. **The unit should not be opened.**

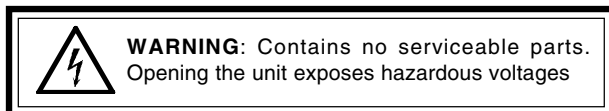

**DISPOSAL**

**COSHH ASSESSMENT FOR DISPOSAL OF IQ CONTROLLER.** The only part affected is the lithium battery (on the battery option board) which must be disposed of in a controlled way.

**RECYCLING.** ♻️

All plastic and metal parts are recyclable. The printed circuit board may be sent to any PCB recovery contractor to recover some of the components for any metals such as gold and silver.



## COMPATIBILITY

- Browsers:** Internet Explorer v6, Mobile smart phones, PDAs (but displays not optimised for small screens, no graphs)
- Supervisors:** 963, 915MDS >v3,
- Utility software:** SET v5 (including IP Tool auxiliary software)
- 4 Line Display:** SDU-xcite (the IQ3xcite label lengths should not be longer than 20 characters for SDU-xcite)
- I/O Modules:** xcite/IO/8UI, 4UI, 4UI/4AO, 2UI/2AO, 8DO, 4DO
- Controllers:** IQ1, IQ2 via EINC (IC Comms with IQ2, IQ1 v4.1 onwards as below)
- IC Comms:** IQ3xcite, IQ2 (including IQL, IQ1 (v3 onwards)). A subset of the IQ2 IC Comms is operational, (see Firmware, IC Comms section).
- IQ2 strategies:** These can be imported into SET, converted into IQ3xcite strategies, and then downloaded into an IQ3xcite. (It is also possible to convert IQ1xx strategies)

The supervisors and tools use different types of communications protocols as shown in the following table:

Function	Comms Level	Software	RJ45 Ethernet	RS232
Set up IP address	Ethernet, MAC	IP Tool (SET application)	Yes	No
Trend Text Comms	Ethernet, IP, UDP, Trend	963, 915MDS, SET	Yes	Yes
Strategy Upload/Download	Ethernet, IP, TCP, FTP	SET	Yes	No
Internet (webpages)	Ethernet, IP, TCP, HTTP, HTML	Browser, 963 (via browser)	Yes	No

## INSTALLATION

The IQ3xcite Controller is installed on a DIN rail via the DIN rail clip, inside a cabinet or panel, using 4 screws and washers. A switch or circuit breaker must be included in the supply to the unit and be in close proximity to it, and must be clearly marked as the disconnecting device for the unit. The procedure involves:

- mount the controller in position
  - connect power, do not power up
  - connect Ethernet
  - connect RS232 (Supervisor/Tool PC, or SDU-xcite)
  - terminate the I/O channels, leave unconnected
  - connect the I/O bus, if used (IQ3XCITE/96/.. only)
  - mount and connect any I/O module (IQ3XCITE/96/.. only)
  - perform input channel linking
- setup address (IP address parameters, Lan number and Device address)
  - power up
  - check Ethernet network
  - configure the strategy and I/O modules used (using SET)
  - download strategy file
  - connect inputs and check operation
  - connect outputs and check operation
  - check web pages using a browser

This installation procedures are covered as follows: IQ3xcite Installation Instructions, TG200626; xcite Standard I/O Modules Installation Instructions, TG200627; XCITE/IC I/O Bus Interconnector Installation Instructions, TG200644; XCITE/TERM I/O Bus Terminator Installation Instructions, TG200645.

## CONNECTIONS

### I/O MODULES (IQ3XCITE/96/... only)

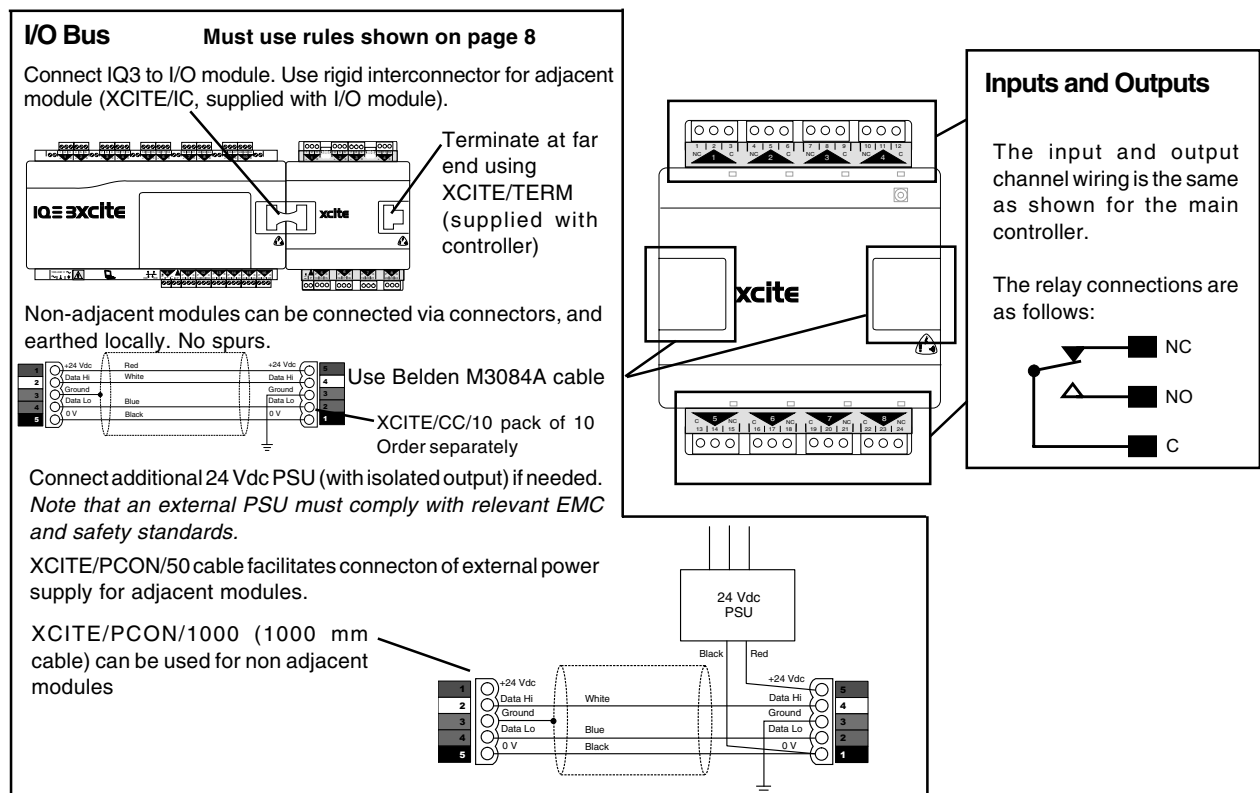

**CONNECTIONS** (continued)

**MAIN CONTROLLER**

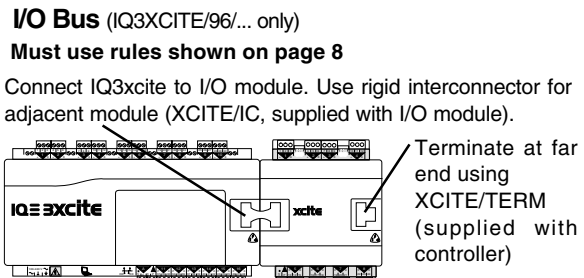
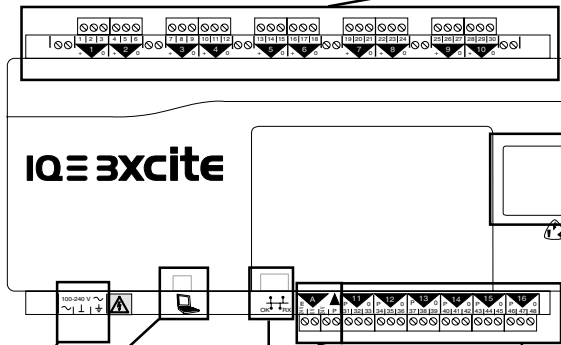
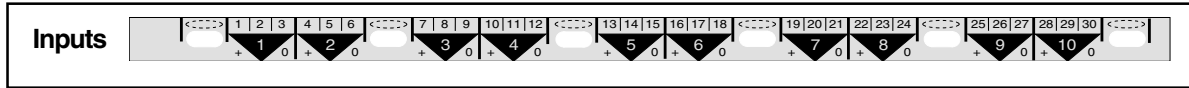

Non-adjacent modules can be connected via connectors, and earthed locally. No spurs.

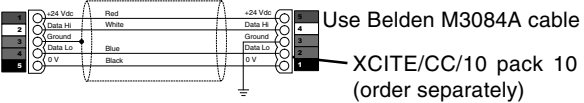

Connect additional 24 Vdc PSU (with isolated output) if needed. *Note that external power supply must comply with relevant EMC and safety standards*

XCITE/PCON/50 cable facilitates connector of external power supply for adjacent modules.

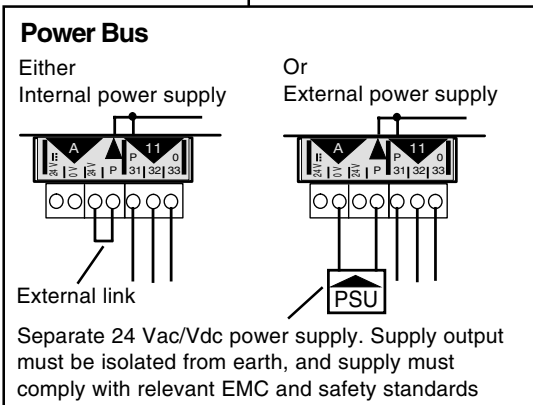
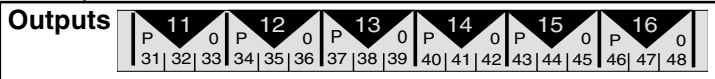
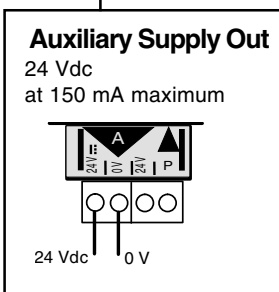
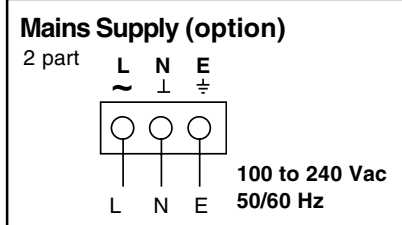
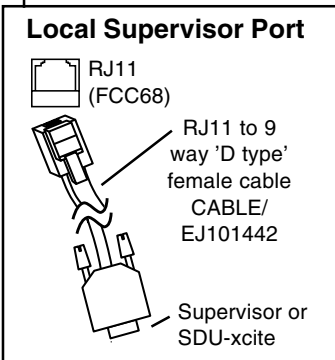
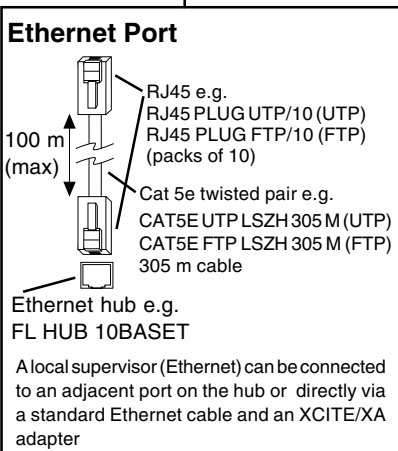
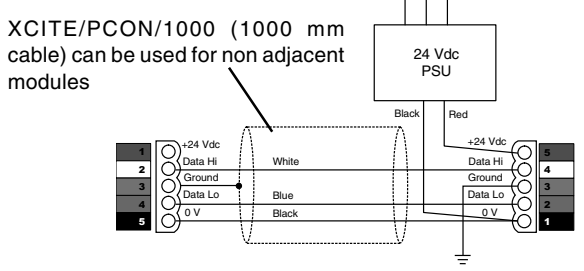

**ORDER CODES**

**IQ3XCITE/16/UK/100-240:** Web enabled controller with 10 Universal Inputs, and 6 Analogue Voltage Outputs, non expandable via I/O bus. Supplied with I/O bus terminator.

**IQ3XCITE/96/UK/100-240:** Web enabled controller with 10 Universal Inputs, and 6 Analogue Voltage Outputs, expandable up to 96 points (i.e. 80 additional I/O channels) by addition of I/O modules to I/O bus. Supplied with I/O bus terminator.

**XCITE/IO/8UI:** 8 channel universal input I/O module. Supplied with rigid interconnector.  
**XCITE/IO/4UI:** 4 channel universal input I/O module. Supplied with rigid interconnector.  
**XCITE/IO/4UI/4AO:** 4 channel universal input and 4 channel analogue voltage output I/O module. Supplied with rigid interconnector.

**ORDER CODES** (continued)

**XCITE/IO/2UI/2AO:** 2 channel universal input and 2 channel analogue voltage output I/O module. Supplied with rigid interconnector.  
**XCITE/IO/8DO:** 8 channel relay output I/O module. Supplied with rigid interconnector.  
**XCITE/IO/4DO:** 4 channel relay output I/O module. Supplied with rigid interconnector.

**XCITE/BBC:** Battery option board increases protection time of clock (in case of mains failure) to several years (e.g for Timemaster).  
**XCITE/IC/5:** Pack of 5 rigid I/O bus interconnectors for adjacent I/O modules (spare)  
**XCITE/TERM/5:** Pack of 5 I/O bus terminators (spare)  
**XCITE/CC/10:** Pack of 10 I/O bus connectors with screw terminals to facilitate wired connection (one required each end).  
**XCITE/PCON/50:** I/O bus interconnector (4 wide) for adjacent I/O modules to facilitate connection of external bus power supply  
**XCITE/PCON/1000:** 1000 mm I/O bus connection cable (4 wide) between I/O modules to facilitate connection of external bus power supply  
**CABLE/EJ101442:** Adapter cable to connect PC to local supervisor port  
**XCITE/XA/5:** Pack of 5 Ethernet connector adapters for direct connection of a PC to the IQ3xcite using a standard Ethernet cable  
**PSR/230/24-1.3:** 1.3 A DIN rail mounted 24 Vdc power supply (isolated output) suitable for supplying I/O modules  
**PSR/230/24-2.5:** 2.5 A DIN rail mounted 24 Vdc power supply (isolated output) suitable for supplying I/O modules  
**SDU-XCITE/UK:** Smart Display unit for IQ3xcite within UK label set. Wall mounting unit with 2x40 electroluminescent display allowing viewing and adjustment of plant parameters and times  
**RD/SDU-IQ2COMMSCABLE/3M:** 3 m cable to connect SDU-xcite to IQ3xcite  
**RD/SDU-IQ2COMMSCABLE/10M:** 10 m cable to connect SDU-xcite to IQ3xcite  
**SDU DOWNLOAD ADAPTOR:** (EJ105174) RJ11 socket to RJ11 plug, download adaptor cable for use with CABLE/EJ10442 for SDU-xcite configuration by PC running SDU Tool (an applet running in SET available from Trend website and protected by licence)  
**FL HUB 10BASET:** 4 port Ethernet hub.  
**FL SWITCH 5TX:** 5 port Ethernet switch  
**FL HUB AGENT:** 4 port Ethernet managed hub  
**CAT5E UTP LSZH 305M:** 305 m of Cat 5e UTP (unshielded) cable for wiring Ethernet connections.  
**CAT5E FTP LSZH 305M:** 305 m of Cat 5e FTP (shielded) cable for wiring Ethernet  
**RJ45 PLUG UTP/10:** Unshielded RJ45 connector for wiring Ethernet connections.  
**RJ45 PLUG FTP/10:** Shielded RJ45 connector for wiring Ethernet connections.

**SPECIFICATIONS****MAIN CONTROLLER****Electrical**

CPU :MCF5272  
CPU speed :66 MHz  
Cycle time :sequence table 1s  
Memory :16 Mbyte SDRAM, and 8 Mbyte Flash.  
Supply voltage :100 to 240 Vac  $\pm$ 10% 50/60 Hz  
Consumption :23 VA max  
24 Vdc combined supply :24 Vdc  $\pm$ 10%, 700 mA maximum (typical) to supply 24 Vdc auxiliary supply terminals, I/O bus, RS232, the I/O channels (see page 6). Output derated to 550 mA for mains supply <200 Vac.  
24 Vdc auxiliary supply :Part of combined supply, 20 to 24 Vdc limited to 150 mA supplied to RS232, 24 V auxiliary, and output power bus.  
Fusing :No replaceable fuses required. The 24Vdc combined supply is protected by a self resetting solid state circuit breaker. The part of the combined supply to RS232, 24 V auxiliary supply and output power bus is protected by 150 mA current limit. The output power bus is protected by a 1.6 A multifuse. The power supply is protected against catastrophic failure by a non-replaceable fuse. The analogue output circuitry is protected against the wrong connection of a non-isolated external supply by a non-replaceable fuse.  
Mains failure protection :All strategy and data in nonvolatile memory. Supercap maintains real time clock for up to 6 days (typical). Option to fit a battery board to maintain clock for up to several years in the case of mains supply failure.  
Battery option :XCITE/BBC, battery option board includes CR2032 3V lithium button cell  
Clock accuracy :30 s per month (typical).  
2-line display panel :SDU-xcite to local supervisor port  
Ethernet :main bus, 10 BASE-T (IEEE 802.3). Supports TCP/IP, FTP  
Supervisor Port  
Transmission :RS232, EIA/TIA/232E, V28 supports Trend comms, PPP  
Distance :15 m

Baud rate :9k6.  
I/O bus :maximum length 30m, 15 additional nodes maximum, 96 points maximum. Signalling rate 125 kbits/s. Cable Belden M3084A.

**Inputs/Outputs** :10 universal inputs, 6 voltage outputs expandable via I/O bus to 96 points maximum

**Universal inputs** :Channels 1 to 10, linkable for analogue voltage (V), analogue current (I), thermistor (T) or digital (D).

Analogue voltage (V) :12 bit resolution. Minimum 60 dB series mode rejection at supply frequency. 0 to 10 V, input resistance 200 k $\Omega$ , accuracy 50 mV equivalent to  $\pm$ 0.5% of span.

Analogue current (I) :12 bit resolution (4096 steps - effective). Minimum 60 dB series mode rejection at supply frequency. 0 to 20 mA, input resistance 240  $\Omega$ , accuracy 0.5% of span (i.e. 100  $\mu$ A). Loop powered input supply is 20 to 36 Vdc.

Thermistor (T) :12 bit resolution. Minimum 60 dB series mode rejection at supply frequency. Thermistor bridge resistor 10 k $\Omega$  0.1%, accuracy 0.5% of span. Bridge supply 5 V.

Digital (D) :voltage free contact. Count rate 30 Hz (minimum pulse width of 20 ms). Wetting current = 3 mA nominal. 5 V supply. Status LED per channel (ON = closed contact).

**Analogue Voltage Outputs** :Channels 11 to 16. 11 bit resolution. 0 to 10 V with 20 mA current limit, accuracy  $\pm$ 0.5% of span.

**Indicators**  
Inputs :(yellow) Indicates status, only for digital inputs (ON= contact closed)  
Analogue Outputs :(yellow) Light intensity increases with output voltage  
⚡ (power) :(green) ON when supply is connected. Flashing at 1 second intervals indicates power supply fault.  
! (watchdog) :(red) ON if controller has a software fault  
!! (I/O bus) :(red) ON if there is an I/O bus fault.  
OK :(green) Normally called LINK on Ethernet systems. ON indicates a good Ethernet connection.  
RX :(yellow) Flashes when packet of data is being received across the Ethernet.

**SPECIFICATIONS** (continued)**Mechanical**

## Dimensions

Controller :263 mm x 150 mm (max.) x 46 mm

Material :Polycarbonate

Protection :IP20

## Weight

Controller :702 gm

IO Module :332 gm (approx.)

## Connectors

Power in :2 part connector with 3 rising cage clamp screw terminals for 0.5 to 2.5 mm<sup>2</sup> cross section area cable.I/O :2 part connectors with rising cage clamp screw terminals for 0.5 to 2.5 mm<sup>2</sup> cross section area cable.Screens :single part connector with rising cage clamp screw terminals for 0.5 to 2.5 mm<sup>2</sup> cross section area cable.

Supervisor port :RJ11 (FCC68), for Trend utility software, supervisor or SDU-xcite connected via adaptor cable CABLE/EJ101442. Can supply signal and power.

Ethernet :RJ45 connector, unshielded or shielded twisted pair (UTP or FTP) cable 10 Mbps, 100 m (10 BASE-T). Cable and connectors available from Trend (see product codes). Connect local supervisor (Ethernet) via adjacent hub or directly using standard Ethernet cable and XCITE/XA adapter

I/O bus :5 wide connector. For expandable controller only, connect with special rigid interconnector (XCITE/IC) supplied with I/O Module to adjacent module, or use connector with screw terminals (XCITE/CC/10 - pack of 10) and wire in Belden M3084A or equivalent. Last connection requires termination (XCITE/TERM supplied with controller). Special 4 wide cables available to facilitate connection of additional I/O bus power supply; XCITE/PCON/50 for adjacent I/O module, XCITE/PCON/1000 for cable connection to I/O module up to 1 metre.

I/O bus

The analogue output bus is protected by a 1.6 A multifuse. The analogue output circuitry is protected against the wrong connection of a non-isolated external supply by a non-replaceable fuse.

I/O bus :maximum length 30 m, 15 additional nodes maximum, 96 points maximum. Signalling rate 125 kbits/s. Cable Belden M3084A (see rules page 8)

**Inputs/outputs**

:selectable from range of 8UI, 4UI, 4UI/4VO, 2UI/2VO, 8RO, or 4RO.

Key:

UI Universal input

VO Analogue voltage output

RO Relay output

:as for main controller

**Universal input****Analogue voltage**

output :as for main controller except 10 bit resolution

**Relay output**

:Relay outputs with LED status indication (on = energised) per channel. Single pole changeover relays. Outputs rated at 5 A maximum for 240 Vac single phase only (use same phase throughout) inductive, (cosφ=0.4), or resistive load, 30 Vdc (resistive load), and 20 Vdc (inductive load). For 24 Vdc (inductive load) reduce to 2 A. Arc suppression recommended, (see Relay Output Arc Suppression Installation Instructions TG200208).

**Indicators**

## Inputs

:(yellow) Indicates status, only for digital inputs (ON= contact closed)

## Analogue Outputs

:(yellow) Light intensity increases with output voltage

## Relay Outputs

:(yellow). Indicates relay status (ON = relay energised)

⚡ (power)

:(green) ON when supply is connected

🐕 (watchdog)

:(red) ON if module has a software fault

🔊 (I/O bus)

:(red) On if there is an I/O bus fault. Flashes at 1 second intervals if the I/O module has not been in receipt of any valid comms for 30 secs (outputs will be switched off). Flashes faster if an address clash on I/O bus, or the address has been set to zero (I/O module disabled)

**Environmental**

## EMC

Emissions :EN50081-1:1992

Immunity :EN61000-3-2:1995 + A1:1998 + A2:1998

EN61000-3-3:1995

EN61000-6-2:1999

## Safety

:EN61010:2001

(Installation Category III - fixed installations)

## Ambient limits

storage :-10 °C to +50 °C

operating :0 °C to 45 °C

humidity :0 to 90 %RH non-condensing

**Version**

This document covers:

Firmware :v1.0

## Boards

IQ3xcite :Baseboard AM104979 Issue 1

CPU board AM104979 Issue 1

## I/O bus

:XCITE/IC AM105225 Issue 1

XCITE/TERM AM105226 Issue 1

**I/O MODULES****Electrical**

CPU :microprocessor PIC 18F458

Supply voltage :24 Vdc ±10%

Consumption :Maximum: 8DO=100 mA, 4DO=60 mA, 8UI=180 mA, 4UI=100 mA, 4UI/4VO=180 mA (+Aux supply 150 mA), 2UI/2VO=100 mA (+Aux supply 150 mA) see page 9 for calculation.

Auxiliary supply :18 to 24 Vdc, limited to 150 mA.

Fusing :no replaceable fuses required. The auxiliary supply is protected by a 150 mA current limit.

**Mechanical**

## Dimensions

I/O Module :130 mm x 150 mm (max.) x 46 mm

## Material

:Polycarbonate

## Protection

:IP20

## Weight

IO Module :332 gm (approx.)

## Connectors

Power in :2 part connector with 3 rising cage clamp screw terminals for 0.5 to 2.5 mm<sup>2</sup> cross section area cable.I/O :2 part connectors with rising cage clamp screw terminals for 0.5 to 2.5 mm<sup>2</sup> cross section area cable.

## Screens

:single part connector with rising cage clamp screw terminals for 0.5 to 2.5 mm<sup>2</sup> cross section area cable.

## I/O bus

:5 wide connector. For expandable controller only, connect with special rigid interconnector (XCITE/IC supplied with I/O Module) to adjacent module, or use connector with screw terminals (XCITE/CC/10 - pack of 10) and wire in Belden M3084A or equivalent. Last connection requires termination (XCITE/TERM supplied with controller)

**Environmental** :as for main controller**Version**

This document covers:

Firmware :v1.00

## Boards

8 relay output AM105145 Issue 1

8 universal input/4 analogue output AM105146 issue 1

Trend Control Systems Ltd reserves the right to revise this publication from time to time and make changes to the content hereof without obligation to notify any person of such revisions or changes.